

Star PP flue

MULTILINE

CASCADE FLUE SYSTEM

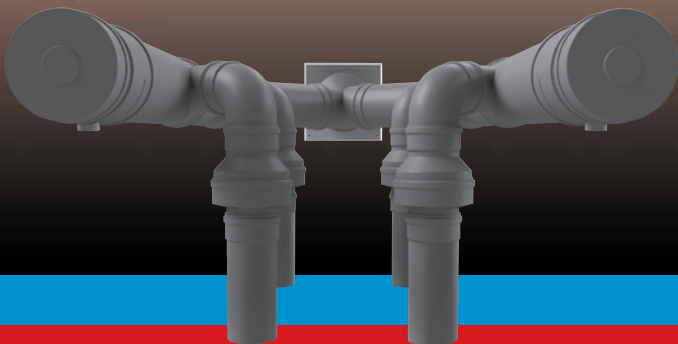

Multiline Robust PP-flue system for multiple boiler installations

**POWER OF
ENGINEERING**



Cooke Industries - Phone: +64 9 579 2185 Email: sales@cookeindustries.co.nz Web: www.cookeindustries.co.nz

The most versatile PP-flue system for cascade	4
Benefit also from the advantage of PP-flue material for cascade	5
Five unique benefits.....	5
Line set-up Ø 130, Ø 150 and Ø 200 mm	6
Back to back set-up Ø 130, Ø 150 and Ø 200 mm	7
Complete programme	
Extension kits line set-up	8
Extension kits back to back set-up	8
End condensate sets	8
Spare collector pipes	8
Various spare parts	
Cascade valve kit	8
Adapter concentric to parallel	9
Adapter double line set-up.....	9
Air intake grill (parallel and concentric).....	9
Air supply grid.....	9
Connection kit.....	9
Siphon	9
Wall bracket	9
PP-Flue material Ø 130, Ø 150 and Ø 200 mm	
PP flue tube	10
PP flue elbow 90°	10
PP flue elbow 45°	10
PP flue elbow 30°	10
PP flue condensate	10
PP flue increasing adapter	11
PP flue reducing adapter.....	11
PP expansion piece	11
PP support elbow.....	11
PP cap	11
Spacer	12
Wall bracket.....	12
Chimney-tops with air intake.....	12
Chimney connection	12
PP roof terminal	13
Flat roof flashing	13

Multiline

The most versatile PP-flue system for cascade

The robust, even gray Multiline system is easily applicable for any cascade set-up of condensing appliances. In this way you can always benefit from the advantages of PP material. The modular system consists of a limited number of components, to build a reliable PP cascade flue system in no-time.

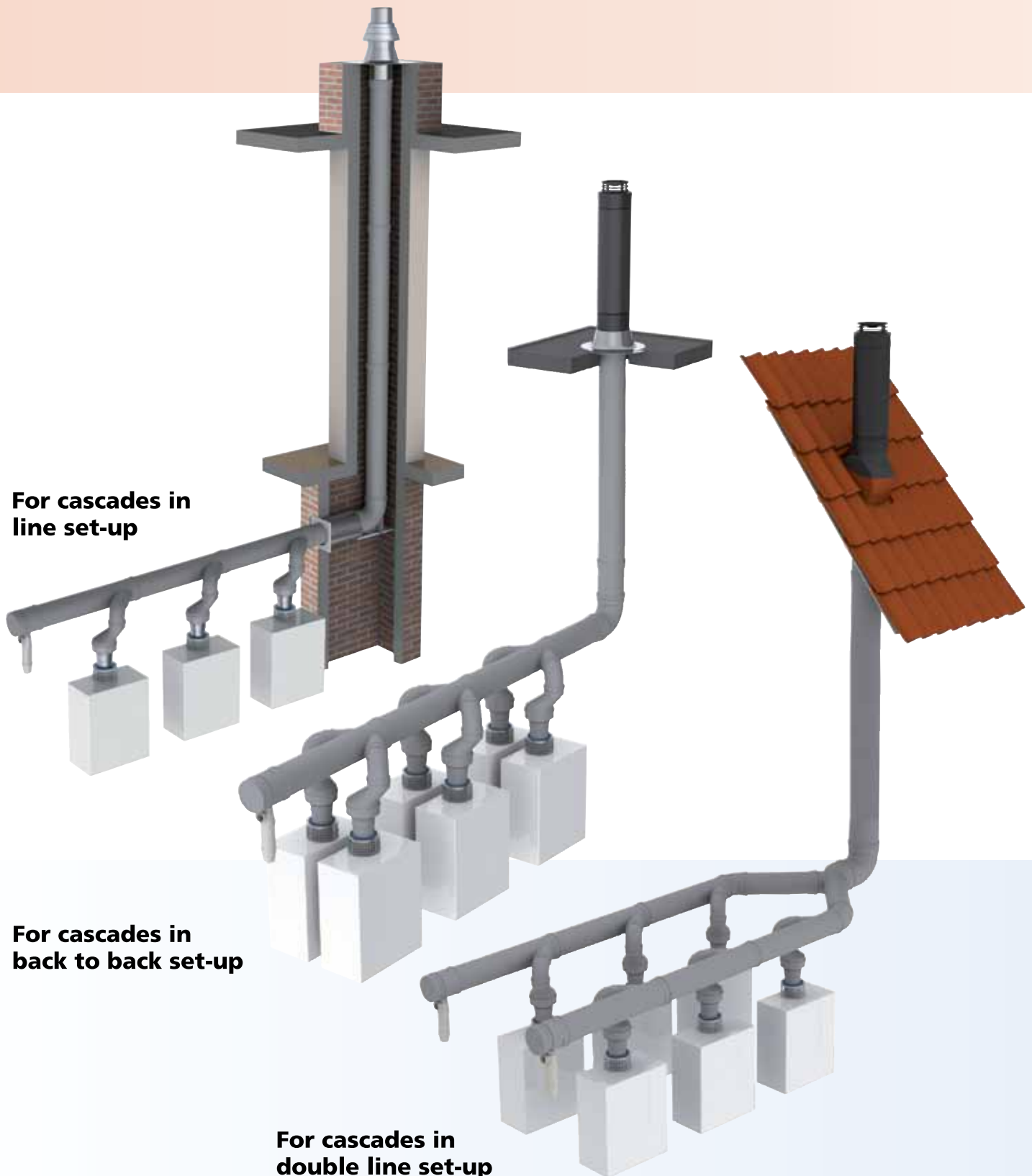

Benefit also from the advantage of PP-flue material for cascade

- **Fast:** PP pipes are lightweight, simply made-to-fit and easy to install.
- **Safe:** no sharp metal edges that could damage or hurt you.
- **Clean:** no corrosion of aluminium, so less pollution in the high efficiency boiler.
- **Sustainable:** the high-grade Multiline material is condensate-resistant and tested for long-life. With CE and ULC approval.

Five unique benefits

1 All-round system, applicable to any cascade

- For line set-ups, back to back set-ups and double line set-ups.
- For overpressure and under pressure systems. In case of an overpressure system, for every boiler a cascade valve is needed. They are included in the delivery sets.
- Standard in three collector pipe diameters: 130, 150 and 200 mm (need another diameter? ask for the possibilities).
- Standard applicable for two to eight appliances, can be extended to bigger configurations.
- Apart from the concentric 100/150 connection on the appliance, a parallel 100-100 connection is also possible.

First consult boiler manufacturer specifications for the correct diameters and lengths.

2 Optiflow-quality, best flue discharge

Multiline is a modular system of high-quality injection moulded parts. This leaves the inner wall completely smooth and the flue discharge will be optimal, because it is unhampered by edges from the welding. The fact that the parts are not welded is also a guarantee for their perfect dimensional stability.

3 Smart elbows, extra sustainable

Multiline elbows do not only have a perfectly smooth inner wall, but they have been constructed in such a way that condensate cannot remain behind. All elbows are fitted with a clever discharge flume. Influence of condensate is thus prevented, which is favourable for the sustainability.

4 Eccentric reduction, robust construction

A Multiline flue system has an eccentric reduction which adjusts the distance to the back of the boiler. This simplifies the installation. In addition, the fact that there are less parts makes the construction more robust.

5 Easy kit, quick and easy to install

A robust even grey Multiline flue system can be put together quickly. The practical basic and extension kits make ordering the necessary kit unbelievably easy.

Condensate end set

A (Ø 130, Ø 150 mm)

1. Condensate collector
2. Cap
3. Siphon

B (Ø 200 mm)

1. Cap
2. Siphon

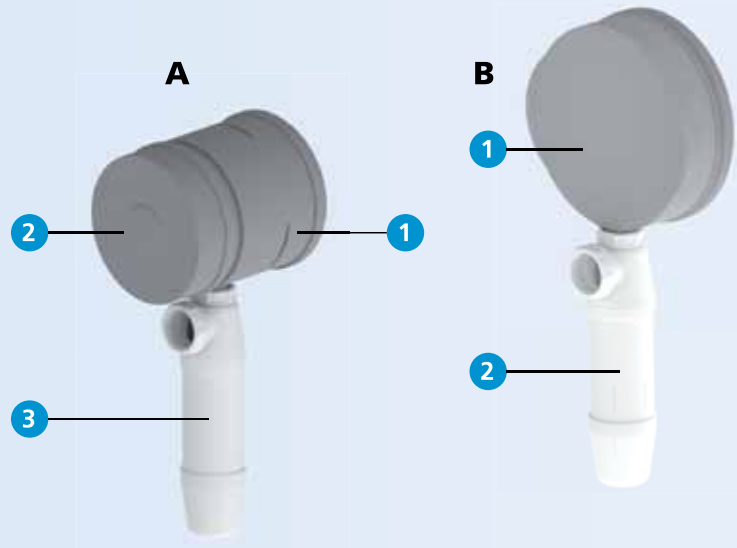

Extension kit line

1. Air intake grill
2. Flue tube, length 500 mm
3. Elbow 90°
4. Collector pipe with connection under 45°
5. Valve

Also available in parallel connection.



Extension kit back to back

1. Air intake grill (2 pcs)
2. Flue tube, length 500 mm (2 pcs)
3. Elbow 90° (2 pcs)
4. Collector pipe with two connections under 45° (2 pcs)



Extension kit back to back

1. Air intake grill (2 pcs)
2. Flue tube, length 500 mm (2 pcs)
3. Elbow 90° (2 pcs)
4. Collector pipe with two connections under 45° (2 pcs)
5. Checkvalve (2pc)



Diameter Multiline collector pipe

The basic and extension kits for line and back to back set-ups can be supplied with a collector pipe of Ø 130, Ø 150 or Ø 200 mm. Does your system need an other diameter? Enquire after the possibilities. In addition, we can make boiler specific cascade kits. We will be pleased to help you find the right solution.

Adapter concentric to parallel

Multiline adapter Ø 100/150 100-100



Adapter double line set-up

Multiline adapter Ø 150-150-200 mm



Air intake grill (parallel and concentric)

Air intake grill Ø 80 mm

Air intake grill Ø 100 mm

Air intake grill Ø 80/125 mm

Air intake grill Ø 100/150 mm



Air supply grid

Bore is 175 cm²



Connection kit

Connection kit 80/80 mm

Connection kit 80/125 mm



Siphon

PP



Wall bracket

Chimney lining

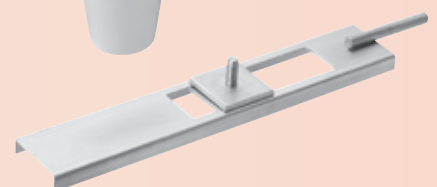

The flue gas parts can be found on the next pages.

MultiLine

PP-Flue material Ø 130, Ø 150 and Ø 200 mm

From connection on collector pipe up to chimney-top

PP flue tube

Ø 130 mm, length 250 mm
Ø 130 mm, length 500 mm
Ø 130 mm, length 1000 mm
Ø 130 mm, length 2000 mm

Ø 150 mm, length 250 mm
Ø 150 mm, length 500 mm
Ø 150 mm, length 1000 mm
Ø 150 mm, length 2000 mm

Ø 200 mm, length 1000 mm
Ø 200 mm, length 2000 mm



PP flue elbow

Ø 130 mm, 90°
Ø 150 mm, 90°
Ø 200 mm, 90°



PP flue elbow

Ø 130 mm, 45°
Ø 150 mm, 45°
Ø 200 mm, 45°



PP flue elbow

Ø 130 mm, 30°
Ø 150 mm, 30°



PP flue condensate

Horizontal/vertical Ø 130 mm
Horizontal/vertical Ø 150 mm
Horizontal Ø 200 mm (cap)



PP flue increasing adapter

Ø 130-150 mm

Ø 150-200 mm



PP flue reducing adapter

Ø 130-100 mm

Ø 150-130 mm

Ø 200-150 mm



PP expansion piece

Ø 130 mm (telescope)

Ø 150 mm (telescope)



PP support elbow

Ø 130 mm

Ø 150 mm

Ø 200 mm



PP cap

Ø 130 mm

Ø 150 mm

Ø 200 mm



MultiLine

PP-Flue material Ø 130, Ø 150 and Ø 200 mm

Spacer

- Ø 130 mm (2 pieces)
- Ø 150 mm (2 pieces)
- Ø 200 mm (2 pieces)

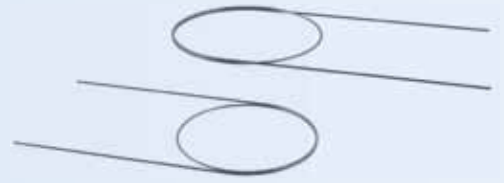

Wall bracket

- Ø 130 mm
- Ø 150 mm
- Ø 200 mm



Chimney-tops with air intake

- PP Ø 130 mm + stainless steel pipe
- Aluminium Ø 150 mm + stainless steel pipe
- Aluminium Ø 200 mm + stainless steel pipe

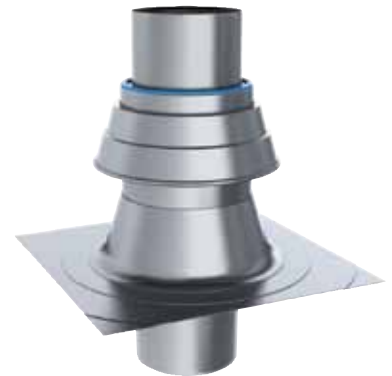

Chimney connection

- Ø 130 mm
- Ø 150 mm
- Ø 200 mm

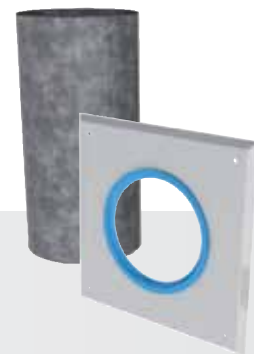

PP roof terminal

- Ø 130 mm
- Ø 150 mm
- Ø 200 mm



Flat roof flashing

- For Ø 130 mm
- For Ø 150 mm
- For Ø 200 mm



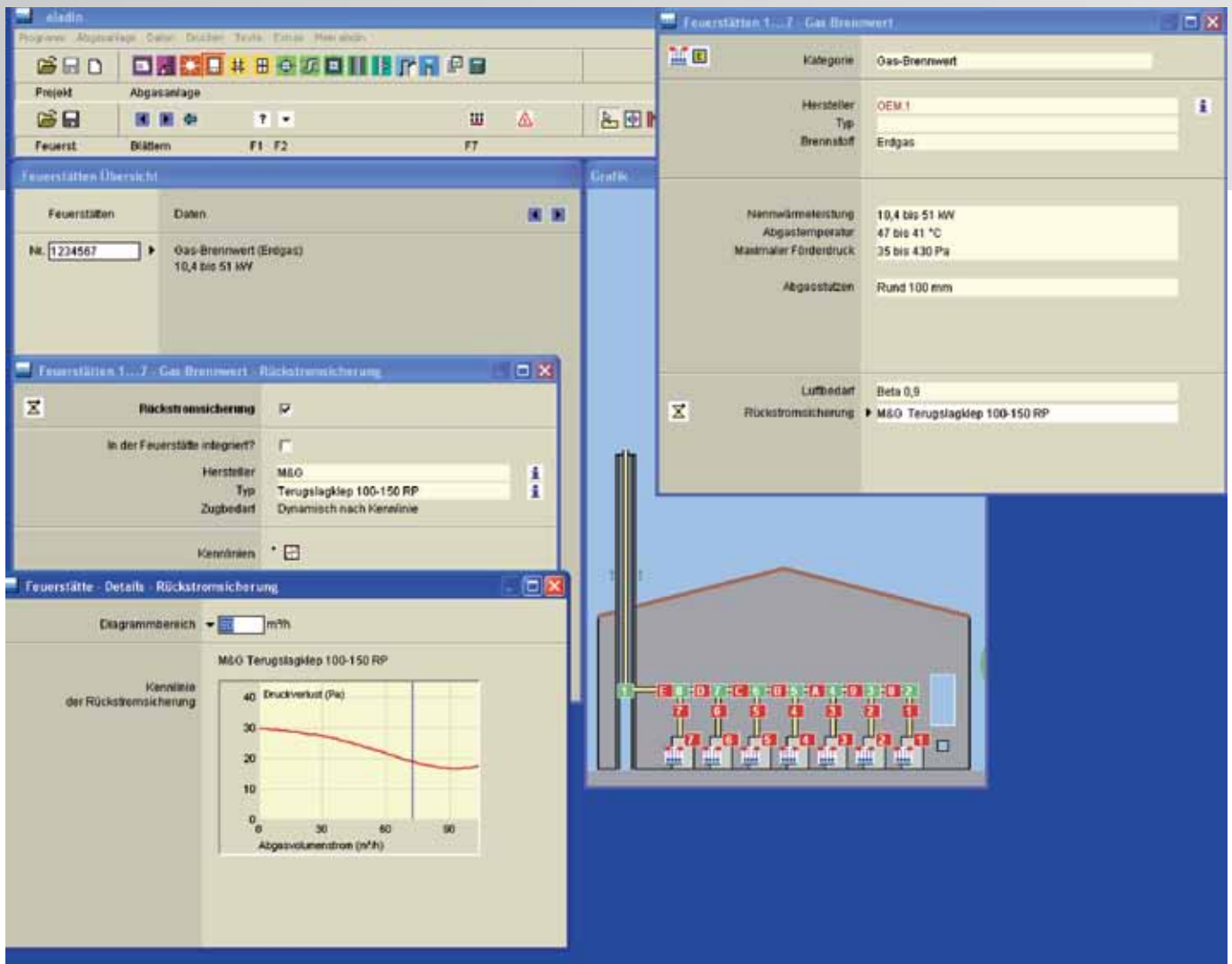

We can help you in calculating the correct cascade setup.

We have developed together with Kesa a comprehensive calculating program based on EN 14483 standard. This software contains all the technical data of the cascade parts to calculate a complete system. A print out presents the results in a clear overview for certification purposes.

M&G Nederland B.V.

Duinkerkenstraat 27
9723 BP Groningen
The Netherlands

T: +31 (0) 50 313 99 44
F: +31 (0) 50 318 54 23
E: info-nl@mg-flues.com

M&G Deutschland GmbH

Rurstrasse 15a
41564 Kaarst
Germany

T: +49 (0) 2131 512900
F: +49 (0) 2131 5129029
E: info-de@mg-flues.com

M&G Flues UK Ltd

2 The Oaks
Mill Farm Courtyard
Beachampton
MK19 6DS
United Kingdom

T: +44 (0) 1908 569887
F: +44 (0) 1908 571206
E: info-uk@mg-flues.com

M&G Italia SPA

Via Campagnola 6
36040 Orgiano (VI)
Italy

T: +39 0444 874808
F: +39 0444 874314
E: info-it@mg-flues.com

www.mg-flues.com



**POWER OF
ENGINEERING**