

PRODUCT CATALOGUE



01 | 2019

 icicaldaie.com







HUMAN TECHNOLOGY

Specialists in excellent solutions

Specialists in the design and production of complete high-tech thermal systems.

Our extensive experience has allowed us to develop a range of highly qualified services capable of meeting any requirements in terms of system management, monitoring and maintenance.

Our extensive experience has allowed us to develop a range of highly qualified services capable of meeting any requirements in terms of system management, monitoring and maintenance.



icicaldaie.com

THE STRENGTH OF ICI CALDAIE

ICI Caldaie is a young and dynamic company, characterised by an indepth knowledge in the industrial field, great production capacity, customer support in the design phase and extreme flexibility in terms of design and production of non-standard boilers, entirely customised based on the customer's specific needs.

Complete system Technical support and constultancy

Each non-standard project is developed by our Technical Department Engineers, and our cutting-edge Research and Development laboratory is entrusted with the development of new products compliant with the increasingly stringent European standards in terms of fuel consumption and emissions. All models produced by ICI Caldaie bear the CE mark and for many of them we have obtained different national certifications for export to Countries that require specific mechanical and hydraulic tests like the ASME - American Society for Mechanical Engineers - certificates.

The international success is the result of high quality standards. ICI Caldaie has obtained international product quality certifications that allow it to produce and distribute its boilers all over the world with top quality and safety features as required by the relevant specific regulations.



CERTIFIED INNOVATION

The awarded certifications are an acknowledgement of our commitment to continual improvement proving the creation, application and maintenance of a Production, Management and Organisation System compliant with international regulations introduced to improve and standardise the internal processes as well as to enhance the effectiveness of the service to customers, thus increasing their satisfaction.

Continued Customer satisfaction is a mark of the company's continual progress

ICI Caldaie has a strong quality culture, based around continual improvement resulting in obtaining system and product certifications such as ISO 9001 certification, CE certification and marks, the construction according to Directives on gas equipment and pressurised tanks, and by several national certifications on the export to Countries that require specific mechanical and hydraulic tests, such as the ASME - American Society for Mechanical Engineers - certificates.

Beside these certifications, the company policy of ICI Caldaie S.p.A. sets further objectives in terms of low environment impact and workers' health and safety. This on-going improvement philosophy has brought ICI Caldaie S.p.A. to obtain the environment certification according to the ISO 14001 standard and the certification on the workers' health and safety as per standard BS OHSAS 18001 (Occupational Health and Safety Assessment Series). ICI Caldaie believes that meeting the Customer needs is essential for the company's continual progress.



ISO 9001 QUALITY CERTIFICATION



OHSAS 18001 HEALTH AND SAFETY CERTIFICATION



ISO 14001 ENVIRONMENTAL CERTIFICATION





COMMERCIAL AREA

With our experience ICI Caldaie S.p.A. Specialised technicians will support you from the initial study to the system sizing or renewal up to the test and monitoring activities of the plant room.

Complete system Technical support and consultancy

We have a presence in countries all around the world, with headquarters and representative offices in Russia, Belarus, Kazakhstan, Romania, Great Britain, USA, China with products certified according to the specific local trade & technical regulations.

-  Commercial subsidiary
-  Representative offices
-  Official distributors

 **ITALY**
Head Quarter

 **U.S.A.**
Representative offices

 **GREAT BRITAIN**
Commercial subsidiary

 **RUSSIA**
Commercial subsidiary

 **ROMANIA**
Commercial subsidiary





The international success is the result of high quality standards. ICI Caldaie has obtained international product quality certifications that allow it to produce and distribute its boilers all over the world with top quality and safety features as required by the relevant specific regulations.

Product certifications



EUROPE



U.S.A.



RUSSIA
BELARUS
KAZAKHSTAN



CHINA



UKRAINE



BELARUS

Representative offices



CHINA

Representative offices



KAZAKHSTAN

Commercial subsidiary



UKRAINE

Representative offices



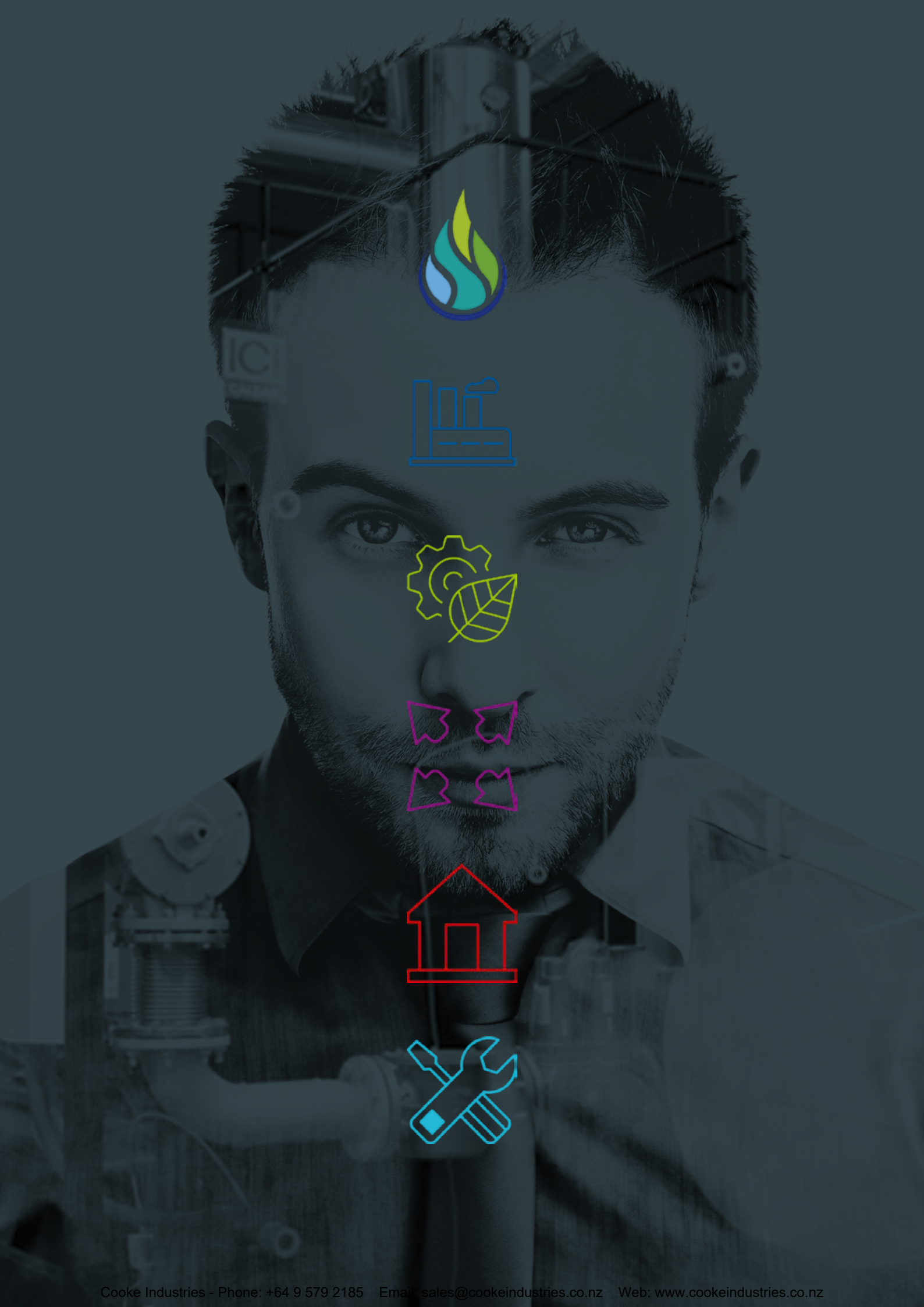



Integrated systems for steam, hot water, superheated water and thermal oil with high water-volume boilers. Energy saving solutions for industrial applications of all kinds.



⊕ STEAM

RANGE	FLASH	p. 36
	FX	p. 38
	BNX	p. 44
	SIXEN	p. 48
	GSX	p. 58
	GX	p. 68
	ISG	p. 80

⊕ SUPERHEATED WATER

RANGE	ASX	p. 86
	ASGX-EN	p. 90

⊕ THERMAL OIL

RANGE	OPX	p. 100
-------	-----	--------

⊕ HOT WATER

RANGE	REX	p. 112
	TNX	p. 116
	TNOX	p. 124
	TNOX S	p. 136

⊕ ACCESSORIES

p. 149

⊕ SYSTEM LAYOUTS

p. 173

The provided figures and data are for reference only.

ICI CALDAIE SpA reserves the right to apply any modification it deems necessary to improve its products, without prior notice.



STEAM

Fire tube steam boilers manufactured as either three-pass or reverse flame type. The offer includes equipment for the production of instantaneous steam at low and high pressure.

All boilers can be combined with the global security systems (GSS) allowing them to be operated unmanned (up to 72 hours, i.e. arrangement 3.).

The steam generation rates are between 50 and 32,000 kg/h.

BNX



DESCRIPTION

Monobloc low-pressure reverse flame wet back steam boiler, suitable for liquid or gaseous fuels.

It is a brand-new boiler, designed to guarantee high-quality steam at low operating pressures and with high peak loads. It has the latest generation user interface equipped with notification and alarm systems, and with optimised dimensions for the installation in small-size heating plant rooms to facilitate routine inspection and maintenance operations.

ADVANTAGES

- + New certification**
CE certification as a whole according to the PED Directive
- + Reduced size**
Redesigned to optimise the dimensions for the installation in small-size heating plant rooms and to facilitate routine maintenance and inspection operations
- + Reliability and durability**
Maximum reliability and durability guaranteed through design with low surface heat losses.

FEATURES

- Design pressure: 0,98 o 0,5 bar**
- Heat output: 69,8 ÷ 2035 kW**
- Steam capacity: 100 ÷ 3000 kg/h**
- Efficiency: > 91,0 %**

For higher or lower pressures see our commercial department

- + High steam quality**
At high load the internal separator prevents the entrainment of water droplets to the steam outlet, the steam produced is then always of high quality having a very high dryness fraction.
- + Simplified user interface**
Latest generation user interface provided with warning and alarm systems
- + Consistant supply of high quality steam**
Thanks to the generously dimensioned steam chamber the boiler can meet the varying demand of the system including instantaneous peak demands

Low-pressure reverse flame steam boiler

MODELS

BNX 0.98 bar

Design pressure: 0,98 bar
 Operating pressure: 0,2 - 0,9 bar
 Heat output: 69,8 ÷ 2035 kW
 Steam capacity: 100 ÷ 3000 kg/h
 Efficiency: > 91,0 %

BNX 0.7 bar

Design pressure: 0,7 bar
 Operating pressure: 0,2 - 0,65 bar
 Heat output: 69,8 ÷ 2035 kW
 Steam capacity: 100 ÷ 3000 kg/h
 Efficiency: > 91,0 %

BBNX 0.5 bar

Design pressure: 0,5 bar
 Operating pressure: 0,2 - 0,45 bar
 Heat output: 69,8 ÷ 2035 kW
 Steam capacity: 100 ÷ 3000 kg/h
 Efficiency: > 91,0 %

The BNX product in the 0.7 bar version is destined to the Russian market.

AVAILABLE CERTIFICATIONS



RECOMMENDED TECHNOLOGIES

MAIN APPLICATIONS

- + Tanning industry
- + Hospitals
- + Dairy Industry
- + Accommodation facilities
- + Distilleries
- + Chemical and pharmaceutical industries
- + Beer industry
- + Manufacturing industry
- + Wine farms

TECHNICAL DATA

Model	Heat output	Flow thermal	Steam capacity *	Volume level H2O	Total volume H2O	Flue gas pressure drop	Gas consump.	Diesel fuel consump.	Nafta consump.	Total weight
BNX	kW	kW	kg/h	l	l	mbar	Nm3/h	kg/h	kg/h	kg
100	69,8	77,4	100	146	198	0,7	7,9	6,5	6,9	650
150	105	115	150	250	410	1,5	11,9	9,8	10,3	830
350	233	256	350	515	805	3,5	26,4	21,8	22,9	1260
500	349	383	500	690	875	3,5	39,6	32,6	34,3	1480
700	465	511	700	800	995	5,0	52,9	43,5	45,8	1580
850	581	639	850	1100	1400	4,5	66,1	54,4	57,2	2180
1000	698	767	1000	1100	1400	6,0	79,3	65,3	68,7	2180
1400	897	985	1350	1560	2010	5,1	100,8	83,1	87,3	2730
1700	1163	1278	1700	1790	2280	7,0	132,3	108,9	114,5	2930
2000	1395	1533	2000	2050	3020	7,5	158,7	130,7	137,4	3830
2650	1744	1917	2650	3100	4240	6,5	198,3	163,3	171,8	5130
3000	2035	2236	3000	3100	4240	7,5	231,4	190,6	200,4	5130

* steam capacity with feed water at 80 ° C

* total weight referring to the single pump model, 0.98 bar

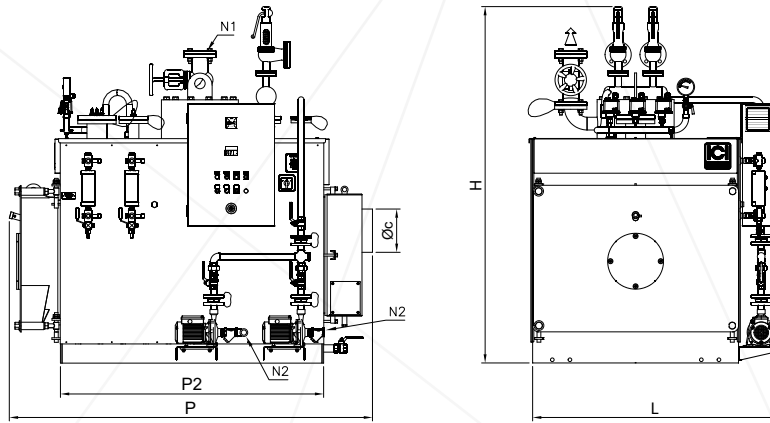

DIMENSIONS

Model	H	L	P	P2	ØC	N1	N2
BNX	mm	mm	mm	mm	mm	DN/in	DN/in
100	1280	1000	1225	820	180	1"1/4	1"
150	1723	1290	1720	1170	200	40	1"
350	2000	1340	2060	1510	250	50	1"
500	2042	1420	2085	1510	250	65	1"
700	2108	1420	2335	1760	250	65	1"
850	2409	1540	2625	2010	300	80	1"
1000	2409	1540	2625	2010	300	80	1"
1400	2325	1770	2625	2010	350	100	1"
1700	2639	1750	2925	2310	350	100	1"
2000	3009	1940	3160	2515	400	125	1"
2650	2923	2080	3720	3015	450	150	1"
3000	2923	2080	3720	3015	450	150	1"

H is the value with spring safety valves; for boilers with balance safety valves the height is reduced by approximately 300 mm

STANDARD EQUIPMENT

Monitoring instrumentation, comprising:

- Large dial 3 way test valve manometer
- Limit pressure switch
- Manual reset safety pressure switch
- Regulation pressure switch (only for versions with 2 pumps)

Blow down system comprising:

- Rapid discharge ball valve with manual lever

Automatic conductivity probe level control system comprising:

- Pump start probe and pump shut-off probe
- 1st and 2nd alarm probes and low level burner lockout
- Safety probe for maximum level

Boiler control panel, IP55 1/N ~ 230V 50 Hz

AVAILABLE CONDITIONS

Single feed water pump

Steam-side accessory unit including

- Steam outlet/crown valve
- balanced safety valve
- Reflex level indicator gauge
- Level indicator gauge drain and shut-off valve unit

Feed water delivery system containing:

- 1 Centrifugal pump for water at 90°C
- 1 feed water shut-off valve
- 1 pump suction filter
- 2 non-return valves

Twin feed pumps

Accessories on the steam side, including:

- Steam outlet/crown valve
- 2 safety valves
- 2 Reflex level indicator gauges
- 2 indicator drain and shut-off valve units

Feed water delivery system containing:

- 2 centrifugal electric pumps suitable for water at 90°C
- 4 delivery shut-off valves
- 2 pump suction filters
- 3 non-return valves

PRODUCT CODES

Model	0,98 bar		0,7 bar
	1 pump	2 pumps	2 pumps
BNX 100	86420100	86420104	86420106
BNX 150	86420150	86420154	86420156
BNX 350	86420350	86420354	86420356
BNX 500	86420500	86420504	86420506
BNX 700	86420700	86420704	86420706
BNX 850	86420850	86420854	86420856
BNX 1000	86421000	86421004	86421006
BNX 1400	86421400	86421404	86421406
BNX 1700	86421700	86421704	86421706
BNX 2000	86422000	86422004	86422006
BNX 2650	86422650	86422654	86422656
BNX 3000	86423000	86423004	86423006

Model	0,5 bar	
	1 pump	2 pumps
BBNX 100	86430100	86430104
BBNX 150	86430150	86430154
BBNX 350	86430350	86430354
BBNX 500	86430500	86430504
BBNX 700	86430700	86430704
BBNX 850	86430850	86430854
BBNX 1000	86431000	86431004
BBNX 1400	86431400	86431404
BBNX 1700	86431700	86431704
BBNX 2000	86432000	86432004
BBNX 2650	86432650	86432654
BBNX 3000	86433000	86433004

ACCESSORIES AVAILABLE FOR THE RANGE

Code	Description	1 Pump		2 Pumps		
		BNX	BBNX	BNX	BBNX	BNX RU
See "Accessories" section	BNX automatic purging system	■	■	■	■	■
See "Accessories" section	Standby feed water pump	■	■			
17090037	Salinity control unit (pneumatic TDS) (starting from BNX 1400)	■	■	■	■	■
17090035	Salinity control unit (electric TDS) (starting from BNX 1400)	■	■	■	■	■
17090051	Salinity control unit (electric light TDS) (up to BNX 1000)	■	■	■	■	■
38040100	Sample cooler	■	■	■	■	■
90060010	High level safety kit	■	■	■	■	■
90060073	2nd stage regulation pressure switch BNX 500-3000	■	■	■	■	■
86900067	Global safety system GSS 72/1 (BNX 100-1000)	■	■	■	■	■
86900073	Safety system GSS 72/2X	■	■	■	■	■
QCTETERM	Eterm Easy manager panel	■	■	■	■	■
90060078	Cascade control panel for steam boilers	■	■	■	■	■

COMPONENTS FOR HEATING PLANT ROOM COMPATIBLE WITH THE RANGE



ECXV
Vertical energy saver
Page 190



DEG
Atmospheric deaerator
Page 202



VRC
Feed water tank
Page 198



ADD
Feed water treatment unit for steam boilers
Page 206



VRC-V
Feed water tank
Page 200



BDV
Blowdown vessel
Page 208



ACCESSORIES

Components designed to be combined with industrial boilers and further improve their performances; products developed to be integrated in high-performance systems.

AUTOMATIC BLOWDOWN FOR BNX BOILERS



Standard equipment

- Rapid opening purge piston valve with pneumatic actuator and return spring
- Compressed air solenoid valve
- Adjustable cycle timer on board of control panel

Technical features

- Blowdown valve diameter in 1"
- Compressed air fitting diameter in 1/4"
- Compressed air pressure - min/max 4/10 bar
- Blowdown interval adjustment range, 0-12h
- Air consumption per cycle 0.62l
- Blowdown duration adjustment range, 0-12s

Accessory included in the standard equipment for:
GSS 72/1



The automatic bottom blowdown unit prevents unnecessary duplication or omission of blowdown that is possible with the manual system. This system allows sludge accumulated at the bottom of the boiler to be regularly and automatically removed through a cyclical opening in the blowdown valve. The system requires compressed air availability.

PRODUCT CODES

Models	Items	Kit code
BNX 100-150	Code as single additional accessory	86900034
	Code with multiple additional accessories	86900037
BNX 350-3000	Code as single additional accessory	86900033
	Code with multiple additional accessories	86900044

AUTOMATIC BLOWDOWN FOR SIXEN - GSX - GX BOILERS



Standard equipment

- Rapid opening purge ball valve, with steel body, pneumatic actuator and return spring
- Compressed air solenoid valve
- Adjustable cycle timer on board of control panel

Technical features

- Blowdown fitting diameter DN 32 *
- * DN 40 for GX boiler models
- Compressed air fitting diameter in 1/4"
- Compressed air pressure - min/max 4/10 bar
- Air consumption per cycle 0.62l
- Blowdown interval adjustment range, 0-12h
- Blowdown duration adjustment range, 0-12s

Accessory included in the standard equipment for:
GSS 72/1 and GSS 72/2X



The automatic bottom blowdown unit prevents unnecessary duplication or omission of blowdown that is possible with the manual system. This system allows sludge accumulated at the bottom of the boiler to be regularly and automatically removed through a cyclical opening in the blowdown valve. The blowdown intervals and duration must be set by the user based on the features of the boiler water as indicated in the boiler technical manual. The system requires compressed air availability.

PRODUCT CODES

Ranges	Items	Kit code
SIXEN	Code as single additional accessory	86900040
	Code with multiple additional accessories	86900039
GSX / GSX P	Code as single additional accessory	86900040
	Code with multiple additional accessories	86900039
GX	Code as single additional accessory	86900036
	Code with multiple additional accessories	86900042

ELECTRIC OR PNEUMATIC TDS SALINITY CONTROL



Standard equipment:

- Conductivity probe with integrated temperature probe
- Steel blowdown valve
- Pneumatic actuator with compressed air solenoid valve, closed in the absence electrical power, or alternatively electric actuator
- Shut-off globe valve
- Non-return valve
- Electric regulator on board of control panel

Accessory included in the standard equipment for:
GSS 72/2X



PRODUCT CODES

Pneumatic TDS	17090037
Electric TDS	17090035

ELECTRIC LIGHT TDS SALINITY CONTROL



Standard equipment:

- Conductivity probe with measurement chamber
- Drain solenoid valve
- Filter
- Shut-off valve
- Electric regulator on board of control panel

Accessory code: 17090051

Accessory included in the standard equipment for:
GSS 72/1



For boilers \leq BNX 1000 \leq SIXEN 2000 and \leq GSX 2000 THE TDS Controls are already electrically and hydraulically connected to the boiler. The TDS control system limits the level of salts and minerals dissolved in the boiler water to the value allowed by the manufacturer thus avoiding any risks of carry over due to excessive levels of salinity and minimising the required blowdown volume and costs. The system consists of an in-line kit connected to a suitable boiler fitting just below the water level. It works by opening the drain valve at regular intervals so that a very precise water quantity reaches the conductivity probe located inside the measurement chamber connected in line with the drain valve. The probe measures the boiler water electrical conductivity value which is proportional to the concentration of dissolved salts. The measured value is compared with the one set at the controller. If the measured value is lower, at the end of the discharge time, the valve closes. If the measured value is higher, the system continues to repeat the discharge cycle until the measured value returns within the limits.

Attention:

This kit can be applied only to boilers with design pressure lower than or equal to 12 bar

SAMPLE COOLER



To make sure that the boiler is working within the desired conductivity parameters, it is necessary to take water samples and analyse them. To take precise samples in a safe way it is essential to perform a proper cooling cycle in order to make any steam formed before the take-off point condense. The cooler reduces the water temperature up to 25°C, ready for immediate sampling.

Standard equipment:

- AISI 304 cylinder with an internal water-cooling coil
- Cooling water injection ball valve
- Handwheel valve for sampling

Accessory code:

38040100

Accessory included in the standard equipment for:
GSS 72/1 and GSS 72/2X



HIGH LEVEL ALARM KIT



Kit designed to prevent an excessive increase of water level inside the boiler. Once the set level is reached, the system stops the supply pump and triggers an acoustic alarm. Alarm resetting and pump restart automatically occur once normal level in the boiler is restored.

Standard equipment:

- Conductivity probe mounted directly on the boiler body for high safety level
- High-level relay in boiler control panel

PRODUCT CODES

General:	90060010
For boilers of the FX or FX DUAL series:	96140110

BACKUP SUPPLY PUMP



The backup pump is supplied to ensure the constant operation of the boiler, avoiding downtime in case of a main pump failure.

The pump is installed in parallel to the service pump and it is controlled in the same way as the service pump.

Both pumps, hydraulically connected to the same feed pipe, are equipped with a non-return valve and a shut-off valve dedicated to each pump to avoid the water flow towards the pump in stand-by conditions.

Standard equipment

- Backup feed pump with characteristics similar to service pump
- Pump suction side filter
- 1 non-return valve on pump downstream
- 2 shut-off valves on pump downstream
- Non-return valve
- General control panel electrical control comprising:
 - Pump 1-pump 2 switch
 - Pump 2 electrical power branch
 - Pump 2 operation indicator
 - Pump 2 alarm indicator

PRODUCT CODES

Kit code	Steam capacity	BNX	SIXEN	GSX	GSX P	GX
87050001	100 ÷ 350	100 ÷ 350				
87050004	500 ÷ 1700	500 ÷ 1700				
87050006	2000 ÷ 3000	2000 ÷ 3000				
87050010	350 ÷ 1500		350 ÷ 1350	350 ÷ 1500	500 ÷ 1500	
87050040	1700		1700			1000
87050050	2000 ÷ 2050		2000	2000	2000	1200
87050715	2500 ÷ 2650		2500	2500	2500	1500
87050720	3000 ÷ 3500		3000 ÷ 3500	3000 ÷ 3500	3000 ÷ 3500	1750 ÷ 2000
87050060	4000		4000	4000	4000	
87050062	4260					2500
87050070	5000 ÷ 5100		5000	5000	5000	3000
87050082	6000				6000	3500
87050092	6800					4000
87050102	8520					5000
87050755	10240 ÷ 12000					6000 ÷ 7000
87050112	13600 ÷ 15300					8000 ÷ 9000
87050122	17000					10000
87050132	20000 ÷ 22000					12000 ÷ 13000
87050142	25000					15000

MODULATING FEED WATER SYSTEM 2-WAY ELECTRIC VALVE



Thanks to this system, the level in the boiler is constantly adjusted by a PID controller that controls the opening of a modulating valve downstream of the supply pump which is always active. The water flow rate is constantly adjusted to meet the steam demand thus avoiding cycles of steam production as can occur with on/off level controls. By ensuring a constant feed water flow to the boiler, it is necessary to use a modulating feed valve when an economiser is installed, in order to ensure correct operation.

Standard equipment

- Capacitive probe with pre-amplifier
- Two-way steel modulating valve with positioner and electric actuator
- Electronic level regulator on board of control panel

PRODUCT CODES

Code	DN	Steam capacity	SIXEN	GSX	GSX P	GX
39060010	15	500 ÷ 1000	500 ÷ 1000	500 ÷ 850	500 ÷ 850	
39060015	15	1100 ÷ 2500	1300 ÷ 2500	1100 ÷ 2500	1100 ÷ 2500	1000 ÷ 1200
39060020	20	2560 ÷ 5100	3000 ÷ 5000	3000 ÷ 5000	3000 ÷ 5000	1500 ÷ 3000
39060025	25	6000 ÷ 8520			6000	3500 ÷ 5000
39060030	40	10240 ÷ 13600				6000 ÷ 8000

MODULATING FEED WATER SYSTEM 1 FEED PUMP WITH INVERTER INTEGRATED

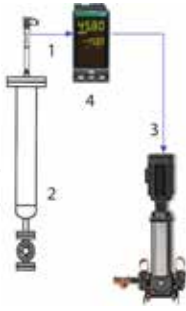

Standard equipment

- 1) Capacitive probe
- 2) Settling chamber
- 3) Inverter on the supply pump
- 4) Electronic level regulator at control panel

BOILER COMPATIBILITY

MODELS	ITEMS
SIXEN 12 bar - single pump	All items
GSX 12 bar - single pump	All items
GSX P 12 bar - single pump	All items
GX 12 bar - single pump	All items

Accessory code:

39050001

MODULATING FEED WATER SYSTEM 2 FEED PUMPS WITH INVERTER INTEGRATED

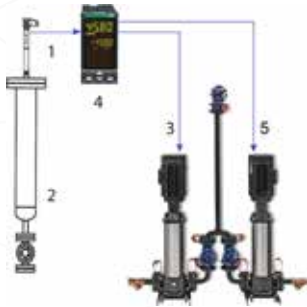

Standard equipment

- 1) Capacitive probe
- 2) Settling chamber
- 3) Inverter on the supply pump
- 4) Electronic level regulator at control panel
- 5) Inverter on the backup pump

BOILER COMPATIBILITY

MODELS	ITEMS
SIXEN 12 bar - double pump	All items
GSX 12 bar - double pump	All items
GSX P 12 bar - double pump	All items
GX 12 bar - double pump	All items

Accessory code:

39050000

MODULATING FEED WATER SYSTEM 2-WAY ELECTRIC VALVE AND 1 FEED PUMP WITH INVERTER INTEGRATED

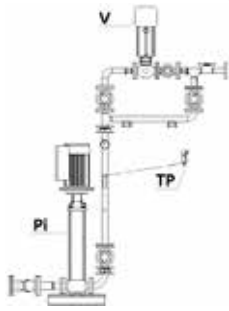

Standard equipment

- Capacitive probe with pre-amplifier
- Two-way steel modulating valve with positioner and electric actuator (V)
- Inverter on the supply pump (Pi)
- Pressure transducer (TP) installed downstream of the pump
- Electronic level regulator on board of control panel

Accessory code:

39050100

With this system, the level in the boiler is constantly adjusted by a PID controller that monitors the opening of a modulating valve downstream the feed pump; the latter adjusts its speed by maintaining a constant pressure downstream the pump itself and then at the modulating valve inlet. Water flow rate is then constantly adjusted to the steam request, thereby preventing a cyclic steam production that may occur with on/off level controls. Furthermore, the number of start-ups and stops of the feed pump are also minimised to the advantage of the pump duration and a lower electrical consumption. By ensuring a continuous water delivery towards the boiler, it is compulsory to use the modulating feed in the presence of the economiser in order to ensure a proper operation.

BOILER COMPATIBILITY

MODELS	ITEMS
SIXEN 12 bar - single pump	All items
GSX 12 bar - single pump	All items
GSX P 12 bar - single pump	All items
GX 12 bar - single pump	All items

MODULATING FEED WATER SYSTEM 2-WAY ELECTRIC VALVE AND 2 FEED PUMPS WITH INVERTER INTEGRATED

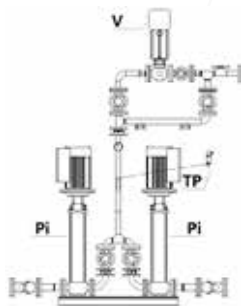

Standard equipment

- Capacitive probe with pre-amplifier
- Two-way steel modulating valve with positioner and electric actuator (V)
- Inverter on the supply pumps (Pi)
- Pressure transducer (TP) installed downstream of the pump
- Electronic level regulator on board of control panel

Accessory code:

39050110

With this system, the level in the boiler is constantly adjusted by a PID controller that monitors the opening of a modulating valve downstream the feed pump; the latter adjusts its speed by maintaining a constant pressure downstream the pump itself and then at the modulating valve inlet. Water flow rate is then constantly adjusted to the steam request, thereby preventing a cyclic steam production that may occur with on/off level controls. Furthermore, the number of start-ups and stops of the feed pump are also minimised to the advantage of the pump duration and a lower electrical consumption. By ensuring a continuous water delivery towards the boiler, it is compulsory to use the modulating feed in the presence of the economiser in order to ensure a proper operation.

BOILER COMPATIBILITY

MODELS	ITEMS
SIXEN 12 bar - double pump	All items
GSX 12 bar - double pump	All items
GSX P 12 bar - double pump	All items
GX 12 bar - double pump	All items

SELF MONITORING HIGH LEVEL ALARM KIT



Standard equipment:

- "Fail Safe" level probe
- Level electronic relay with self-diagnosis feature

This system ensures that the level in the boiler does not exceed the allowed value thus avoiding flood problems. It consists of a "fail safe" probe connected to an electronic level relay with self-diagnosis feature, capable of indicating:

- the presence of water above the set level;
- the lack of insulation inside the probe;
- faults inside the device (self-diagnosis);
- interruption of the connection between the probe and the device in compliance with EN 12953-9 point 5.4.8.

When it trips, the system triggers a visual and an acoustic alarm and stops the supply pump temporarily. The alarm is reset automatically once the level is again below the allowed maximum value.

The system is supplied completely assembled to the boiler and tested. It complies with the main European Directives:

- Low Voltage Directive 2014/35/EU
- EMC Directive 2014/30/EU
- PED Directive 2014/68/EU

Accessory code:

90060040

SELF MONITORING LOW LEVEL ALARM KIT



Standard equipment:

- 2 "Fail Safe" independent level probes
- 2 level electronic independent relays with self-diagnosis feature

This system, supplied as an alternative to the standard low level probes, is designed to ensure that the level in the boiler does not go below the allowed value. It consists of two independent "fail safe" probes connected to two separated electronic level relays with self-diagnosis feature, capable of indicating:

- the lack of water below the set level;
- the lack of insulation inside the probe;
- faults inside the device (self-diagnosis);
- interruption of the connection between the probe and the device in compliance with EN 12953-9 point 5.4.8.

When it trips, the system triggers a visual and an acoustic alarm and stops the boiler permanently. The boiler operation is resumed only after the manual reset and the elimination of the error by the operator.

The system is supplied completely assembled to the boiler and tested. It complies with the main European Directives:

- Low Voltage Directive 2014/35/EU
- EMC Directive 2014/30/EU
- PED Directive 2014/68/EU

Accessory code:

90060050

Accessory included in the standard equipment for:
GSS 72/1 and 72/2X



ETERM EASY MANAGER PANEL



Control panel with 15" touch screen for a personalised view of the heating plant room (synoptic diagram).

The panel must be connected via bus to the boiler Eterm control panels and to Nereix devices (plant and/flat metering devices)

From the graphic panel it is possible to:

- view the instantaneous values of temperature, operating status, modulation percentage values, alarms, etc.

- send starting, stopping, forcing, setpoint and other types of commands
- view graphs of the saved variables
- export images of the graphs and Excel tables of the log data
- view the alarm log

Control panel with 15" touch screen for a personalised view of the heating plant room (synoptic diagram).

The panel must be connected via bus to the boiler Eterm control panels and to Nereix devices (plant and/flat metering devices)

From the graphic panel it is possible to:

- view the instantaneous values of temperature, operating status, modulation percentage values, alarms, etc.
- send starting, stopping, forcing, setpoint and other types of commands
- view graphs of the saved variables
- export images of the graphs and Excel tables of the log data
- view the alarm log

The ModBus RS485 port (2 wires) is available for only one of the following options:

1- ModBus Master

ModBus slave device management, i.e. the ability to manage other devices featuring the same interface from the graphic page.

(ICI Caldaie reserves the right to check the compatibility of the devices)

2-ModBus Slave

Conversion of all eterm parameters, both in reading and in writing mode, in ModBus protocol for external supervision systems provided with such interface.

The maximum number of parameters that can be provided is 500 and they can be chosen by the customer based on the system.

The control panel is provided with a device for Internet connection:

the type of preferred connection determines the type of device installed inside the panel.

The versions/connections are divided in:

QCTETERM01	MODEM 2G/3G
QCTETERM02	LAN use
QCTETERM03	Wi-Fi

When placing your order, please confirm the type of configuration chosen and the type of connectivity available in the plant room

These connections allow to:

View and manage, from any device provided with browser, the same synoptic diagram available on the touch screen.

(Considering the constant evolution of the browser, ICI Caldaie reserves the right to indicate the fully compatible synoptic diagrams for a correct display)

Receive remote assistance for the configuration of all connected devices with considerable time and cost saving:

in case of electronic board replacement

in case of changes to the configuration required for optimisation after a test

(example of threshold setting PID regulation, etc.)

CASCADE CONTROL PANEL FOR STEAM BOILERS

Separate control panel for managing the sequence of two or more steam boilers
It is available in three different configurations:

- EASY
- PLUS
- LOAD SHARING

running the sequence operation of steam boilers with different logics (and software).

Accessory code: 90060078

When placing your order, please confirm the type of configuration chosen and the type of connectivity available in the plant room.

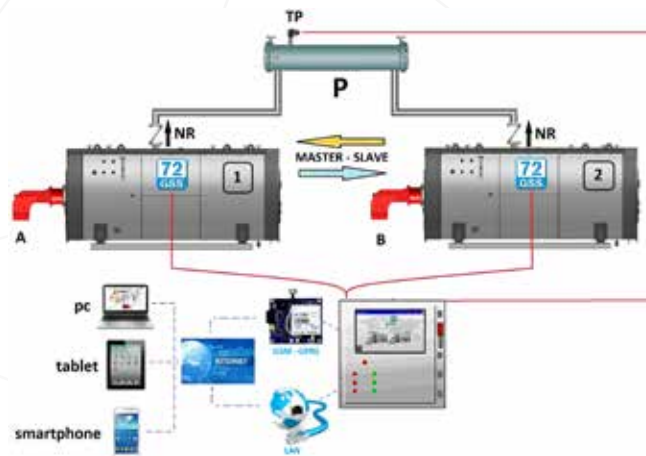

EASY configuration

Boiler priority is given by setting the working pressures on each boiler, higher set pressure for the MASTER boiler and slightly lower pressure for the SLAVE, thus obtaining the boiler sequence.

PLUS configuration

The PLUS configuration manages and limits the output of the burners.

By setting a set limit and a set point for boiler operation, the sequencing panel sends the settings to all boilers in parallel. If the MASTER burner output falls below a set percentage for a certain time, the SLAVE boiler reaches a stand-by set point. Vice versa, when the MASTER burner exceeds the set percentage for a certain time, the SLAVE goes back to the normal operation set point.

LOAD SHARING configuration

By setting a P pressure set point on the manifold, and its control PID, A POWER REQUEST IS GENERATED for the steam boilers, ranging from 0 to 200% (e.g. in case of 2 boilers).

Boiler requirements.	CONFIGURATION		
	EASY	PLUS	LOAD SHARING
GSS 72/2X	■	■	■
Non-return valve	■	■	■
Pressure transducer	■	■	■
NO Feedback from the burner	■		
Feedback from the burner		■	■
Electric steam valve			■
Connectivity in heating plant room (eterm)	■	■	■

GLOBAL SAFETY SYSTEM GSS 72 FOR STEAM BOILERS



Global safety system designed and manufactured to ensure a total operating safety for **steam boilers**, in accordance with applicable regulations in terms of exemption from continuous supervision up to 72 hours. The boiler equipped with this system is certified as "Assembly" in compliance with the Directive PED 2014/68/EU according to the following modules:

- **module B+F** for boilers intended for Italian market which implies testing the assembly, during its construction or use, in the presence of a Notified Body in charge. A test report is officially completed and stamped at start-up, allowing the immediate commissioning of the unit without having to wait for competent Bodies to certify, according to scheduled times, the system safety. The user is responsible for the observation of the provisions by the Ministerial Decree 329/2004 on commissioning (DECLARATION OF COMMISSIONING).

- **module B+D** for boilers intended for the foreign market.

The system consists of a series of equipment assembled and electrically and hydraulically tested at our facility, and specifically:

GSS 72/1	86900067 *
GSS 72/2X	86900073

*** ATTENTION: The GSS 72/1 system can be applied only on boilers with rated pressure equal to or lower than 12 bar**

Compatible products:

- BNX 100 - 1000
- SIXEN 350 - 2000
- GSX 350 - 2000
- GSX P 500 - 2000

Salinity control unit (TDS) containing:

- conductivity probe
- salinity regulation and control unit
- electric or pneumatic blowdown system, complete with shut-off valves.
- electrical controls in general control panel of the boiler

Automatic sludge removal unit, able to prevent the accumulation of sludge in the boiler body, composed of:

- 2-way pneumatic valve made of steel, with lever for manual operation
- PLC for adjusting opening frequency and duration
- compressed air solenoid valve
- connections and electrical controls in general control panel of the boiler

High level safety probe mounted directly in the boiler body

Boiler control panel certified for safety chain management, complete with PLC and operator panel able to monitor and display status signals and alarms, and specifically:

- boiler ON
- control panel power supply
- boiler pressure view
- hot water level view (optional)
- modulating supply management presetting (optional)
- burner control
- feed water pump status view
- steam high pressure safety shut-off
- water low level safety shut-down
- salinity alarm
- burner in operation
- burner shut-off
- cumulative alarm signal system

Sample cooler mounted directly in the boiler body

All the supplied material, with particular attention to the control panel and the electric system, is produced in compliance with the prevailing European Standards and precisely:

- Directive 2014/68/EU
- Directive 2014/35/EU
- Directive 2014/30/EU
- Standards EN 50156-1: 2006
- The entire system will be provided with the CE mark as a whole in compliance with the European Directive 2014/68/EU and tested at Your Facility with the setting of the functional parameters.

System main components and functions:

Auto controlled safety level unit containing:

- 2 low level safety probes, mechanically and electrically independent, mounted directly in the boiler body, with manual reset and self-test, complete with burner shut off relay
- connections and electrical controls in general control panel of the boiler

Safety pressure unit containing:

- "Fail Safe", manual reset safety pressure switch, complete with burner shut off relay
- connections and electrical controls in general control panel of the boiler

GLOBAL SAFETY SYSTEM GSS 72 WHB



GSS 72 global safety system designed and manufactured to ensure the total safety of **steam boilers with a thermal source other than fire**.

The delivery of the global security systems for making them unmanned up to 72 hrs by ICI CALDAIE is provided with the **B+F certification module** that implies the test of the entire assembly at the manufacturing or use facility, in presence of an appointed Notified Body.

Upon commissioning, an inspection report is officially filled in and stamped to allow **the immediate start-up** of the assembly without waiting for competent Authorities to test the system safety, with the relevant required waiting time. It is the responsibility of the user to respect the Italian Ministerial Decree No. 329/2004 on commissioning (DECLARATION OF COMMISSIONING).

Accessory code:

86900071

System main components and functions:

Level safety unit auto controlled, consisting of:

- 2 low level safety probes, mechanically and electrically independent, mounted directly in the boiler body, with manual reset and self-test, complete with burner shut off relay
- connections and electrical controls in general control panel of the boiler
- mechanical and electric parts

Safety pressure unit consisting of:

- "Fail Safe", manual reset safety pressure switch, complete with burner shut-off relay
- connections and electrical controls in general control panel of the boiler
- mechanical and electric parts

Salinity control unit (TDS) consisting of:

- conductivity probe
- salinity regulation and control unit
- electric or pneumatic blowdown system complete with shut-off valves
- electrical controls in general control panel of the boiler
- mechanical and electric parts

Automatic sludge removal unit, able to prevent the accumulation of sludge in the boiler body, composed of:

- 2-way pneumatic valve made of steel, with lever for manual operation
- PLC for adjusting opening frequency and duration
- compressed air solenoid valve
- connections and electrical controls in general control panel of the boiler
- mechanical and electric parts

High level safety probe

- mounted directly in the boiler body

Sample cooler

- mounted directly in the boiler body

STEAM

SUPERHEATED WATER

THERMAL OIL

HOT WATER

ACCESSORIES

SYSTEM LAYOUTS



SYSTEM LAYOUTS

SYSTEM LAYOUT

System layout with condensate recovery, for boilers of the following models:
 FX-BNX-SIXEN-GSX-GSX P-GX-GXC

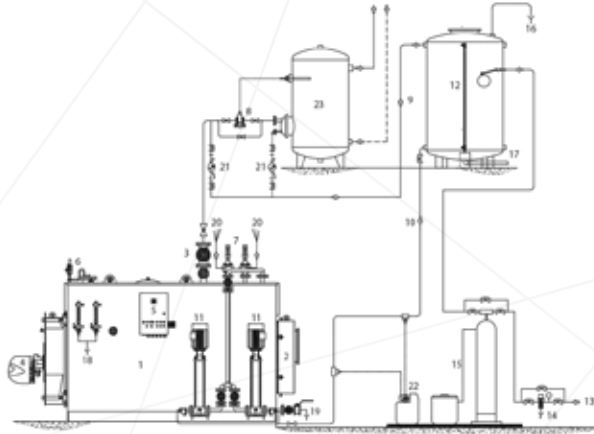

Description

- | | | |
|---------------------|-------------------------------|--|
| 1.Boiler | 9.Condensate return line | 17.Condensate tank drain |
| 2.Smokebox | 10.Pump power supply | 18.Level indicator drain |
| 3.Steam outlet | 11.Supply pumps | 19.Boiler drain |
| 4.Burner | 12.Condensate collection tank | 20.Safety valve drain |
| 5.Control panel | 13.Water supply | 21.Steam trap |
| 6.Pressure switches | 14.Filter | 22.Dosing pump |
| 7.Safety valves | 15.Water treatment | 23.Use: industrial or d.h.w water heater |
| 8.Control valve | 16.Vent | |

System layout without condensate recovery, for boilers of the following models:
 FX-BNX-SIXEN-GSX-GSX P-GX-GXC

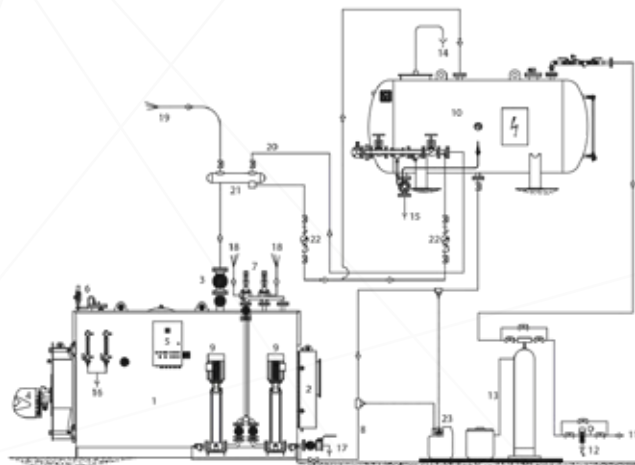

Description

- | | | |
|---------------------|--------------------------|--------------------------------|
| 1.Boiler | 9.Supply pumps | 17.Boiler drain |
| 2.Smokebox | 10.Deaerator | 18.Safety valve drain |
| 3.Steam outlet | 11.Water supply | 19.Direct use with waste steam |
| 4.Burner | 12.Filter | 20.Deaerator steam supply |
| 5.Control panel | 13.Water treatment | 21.Steam header |
| 6.Pressure switches | 14.Vent | 22.Steam trap |
| 7.Safety valves | 15.Tank drain | 23.Dosing pump |
| 8.Pump power supply | 16.Level indicator drain | |



Range of products and accessories dedicated to heat recovery.

Solutions characterised by production flexibility, capable of satisfying any market requirement, regulatory constraint or installation criticality.

ENERGY EFFICIENCY AREA



ENERGY EFFICIENCY

RANGE	WH	p. 184
	BAX	p. 188
	ECXV	p. 190
	ECO-G	p. 192
	Fin-e	p. 194

The provided figures and data are for reference only.

ICI CALDAIE SpA reserves the right to apply any modification it deems necessary to improve its products, without prior notice.

WH



DESCRIPTION

The waste-heat boilers of the WH range recover energy from hot flue gases as heat source without any supplementary combustion. These boilers are of the monobloc type, with fully automatic operation and are provided with all accessories required for quick commissioning. The WH range is characterized by a great flexibility of design and use; the boilers are designed specifically to meet any particular requirements.

ADVANTAGES

- + **Modular versions**
The boiler is available as flexible modular sections dependant on the range of required power.
- + **High water content**
- + **High operating flexibility**

FEATURES

- + **Design pressure from 1 to 25 bar**
- + **Heat output 100 ÷ 20000 kW**

- + **Easy, fast and safe installation**
The installation is very easy: you just need to connect the system to the electric, hydraulic, steam and discharge lines.
- + **Assembly and test performed in the factory**
- + **Minimum operating costs**

Waste heat recovery boiler

MODELS



WHB

Design pressure: 1 ÷ 25 bar

Steam capacity: 50 ÷ 32000 kg/h

Steam boiler with fire tubes, waste heat recovery and monobloc type, compliant with the PED Directive 2014/68/EU for indoor or outdoor installations. Complete with regulation and safety accessories for the automatic operation and control panel certified to manage the safety links of the entire boiler.



WHS

Design pressure: 4,9 ÷ 12 bar

Heat output: 233 ÷ 17000 kW

Super-heated water boiler with fire tubes, waste heat recovery and monobloc type, compliant with the PED Directive 2014/68/EU for indoor or outdoor installations. Complete with regulation and safety accessories for the automatic operation and control panel certified to manage the safety links of the entire boiler.



WHO

Design pressure: 10 bar

Heat output: 116 ÷ 9300 kW

Thermal oil heater with water finned pipes, waste heat recovery and monobloc type, compliant with the PED Directive 2014/68/EU for indoor or outdoor installation. Complete with regulation and safety accessories for the automatic operation and control panel certified to manage the safety links of the entire boiler.



WHC

Design pressure: 6 ÷ 25 bar

Heat output: 3000 ÷ 25000 kW

Hot water boiler with fire tubes, waste heat recovery and monobloc type, compliant with the PED Directive 2014/68/EU for indoor or outdoor installations. Complete with regulation and safety accessories for the automatic operation and control panel certified to manage the safety links of the entire boiler.

AVAILABLE CERTIFICATIONS



RECOMMENDED TECHNOLOGIES



APPLICATIONS

INDUSTRIAL PROCESSES

- Furnaces
- Post-combustion chamber
- Incinerators
- Industrial processes with flue gas at high temperature

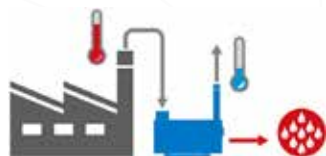

POWER PLANTS

- Turbogas plants

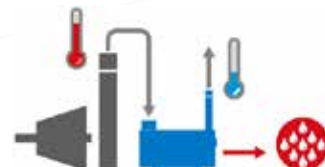

COGENERATORS

- Diesel engines
- Gas and biogas engines
- Vegetable oil engines

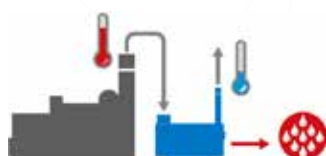

BIOMASS PLANTS

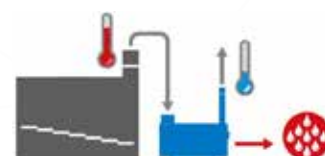

AVAILABLE ACCESSORIES

Code	Description	WH			
		B	S	O	C
See "Accessories" section	Automatic blowdown system for boilers of the SIXEN and GX series	■			
17090037	Salinity control unit (pneumatic TDS)	■			
17090035	Salinity control unit (electric TDS)	■			
38040100	Sample cooler	■			
See "Accessories" section	Standby feed water pump	■			
See "Accessories" section	Modulating level regulation with electric valve	■			
See "Accessories" section	Modulating level regulation with pump/s + inverter	■			
See "Accessories" section	Modulating level regulation, panel + inverter for 1 pump	■			
See "Accessories" section	Modulating level regulation, panel + inverter for 2 pumps	■			
90060010	High level safety kit	■			
90060040	Self-checking High level safety unit	■			
90060050	Self-checking Low level safety units	■			
86900071	GSS72/WH global safety system	■	■	■	■
90060060	Ladder and handrail	■	■	■	■
90060090	Side platform	■	■	■	■
90060070	2nd stage regulation pressure switch	■	■	■	■
90060078	Cascade control panel for steam boilers	■	■	■	■
QCTETERM	Eterm Easy manager panel	■	■	■	■

COMPATIBLE COMPONENTS FOR HEATING PLANT ROOM



ECXV
Vertical energy saver
Page 190



VEX
Steam accumulator
Page 213



VRC
Feed water tank
Page 198



VRC-V
Feed water tank
Page 200



DEG
Atmospheric deaerator
Page 202



EVX
Indirect steam boiler
Page 210



DEG/P
Atmospheric deaerator
Page 204



STORAGE TANK
Thermal oil
Page 216



ADD
Feed water treatment unit for steam boilers
Page 206



VEO
Thermal oil expansion vessel
Page 212



BDV
Blowdown vessel
Page 208



VEA
Super-heated water expansion vessel
Page 214

BAX



BAX is a condensing heat recovery unit built from AISI 316 Ti stainless steel that must be located after the flue gas exit output of boilers running only on natural gas or LPG. The flue gases passing through the recovery unit undergo a considerable reduction in temperature, and, if the system return temperature is below 57°C, the water contained in the gas condenses by exploiting the latent heat of condensation. The recovery unit must be hydraulically connected in series to matching boiler; the increase in water temperature is only a few degrees centigrade and it is therefore necessary to verify the minimum working temperature allowed by the boiler.

TECHNICAL DATA

Model	Code	Boiler power	Heat output		Flue gas pressure drop	Flue gas T at output		Condensate production Delivery/ Return T 50/30°C	Hydraulic pressure drop	Total capacity	Total weight
			Return T 60°C	Return T 30°C		Return T 60°C	Return T 30°C				
			kW	kW		°C	°C				
BAX 88	88220011	500	529,7	591	0,06	68,5	38,5	80	7	393	310
		1000	1057,4	1169	0,25	72,6	42,6	144	27	393	310
		1500	1583,1	1740	0,56	76,7	46,7	201	61	393	310
		2000	2106,8	2306,9	1	80,8	50,8	254	108	393	310
BAX 128	88250018	1500	1585,9	1752,6	0,26	72,9	42,9	215	28	610	570
		2000	2111,8	2324	0,47	75,7	45,7	272	49	610	570
		2500	2636,3	2892,4	0,74	78,5	48,5	326	77	610	570
		3000	3159,5	3458,2	1,06	81,3	51,3	379	111	610	570
BAX 200	88220025	2500	2642,5	2917,5	0,3	73,5	43,5	355	23	626	1254
		3000	3168,4	3488,7	0,43	75,3	45,3	411	33	626	1254
		3500	3693,4	4058	0,59	77,1	47,1	466	44	626	1254
		4000	4217,5	4625,6	0,77	78,9	48,9	520	58	626	1254
BAX 230	88220035	3500	3696,2	4069,1	0,45	75,4	45,4	478	17	831	1619
		4000	4221,2	4638,3	0,58	77	47	533	23	831	1619
		4500	4745,4	5206,1	0,74	78,6	48,6	587	29	831	1619
		5000	5268,8	5772,5	0,91	80,1	50,1	640	36	831	1619
BAX 290	88220050	4500	4751,8	5229,7	0,46	75,6	45,6	613	29	896	2088
		5000	5276,8	5798,9	0,57	76,9	46,9	668	36	896	2088
		5500	5801,1	6366,9	0,69	78,1	48,1	722	43	896	2088
		6000	6324,8	6933,9	0,82	79,4	49,4	775	51	896	2088
BAX 350	88220070	5500	5807,4	6390,3	0,48	75,8	45,8	747	43	1036	2590
		6000	6332,3	6959,5	0,57	76,8	46,8	802	51	1036	2590
		6500	6856,8	7527,6	0,66	77,8	47,8	857	60	1036	2590
		7000	7380,7	8094,9	0,77	78,9	48,9	910	70	1036	2590
		8000	8430	9200	1	84	53	1015	91	1036	2590

CONDENSING HEAT RECOVERY UNIT

MODEL 88 ÷ 128

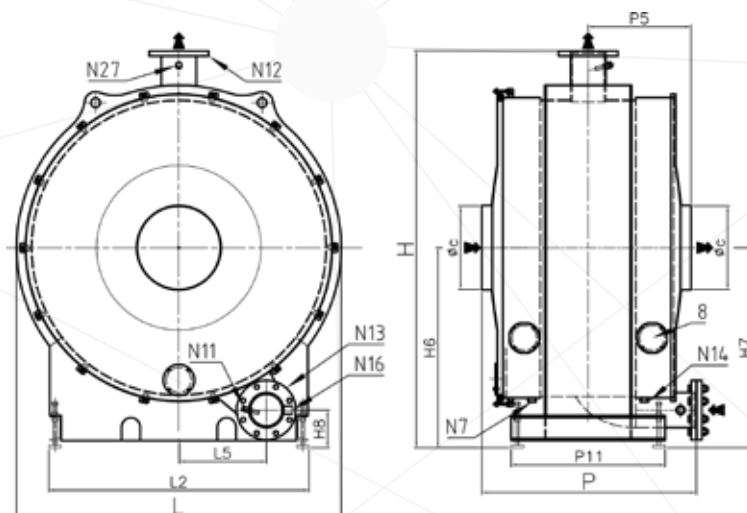

BAX 200 ÷ 350

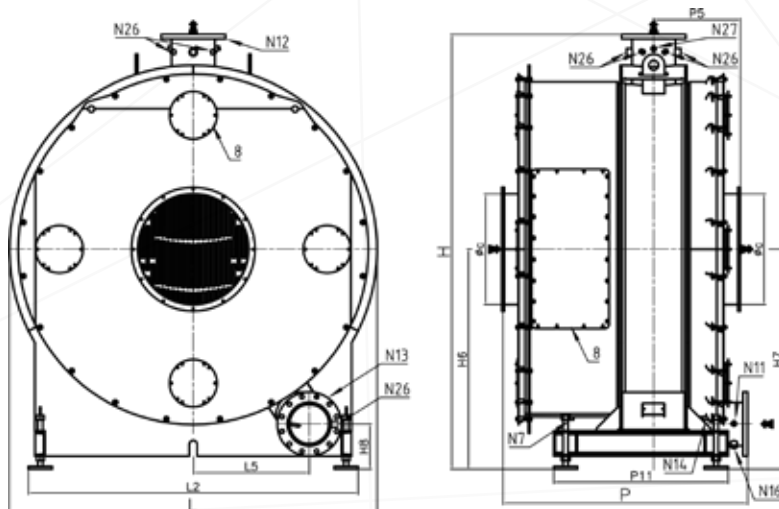

Key:

N7 Boiler-side condensate drain
N11 Return temperature control
N12 Recovery unit delivery
N13 Recovery unit return

N14 Chimney-side condensate drain
N16 Condenser drain
N27 Delivery temperature control

DIMENSIONS

Model	H	H6	H7	H8	L	L2	L5	P	P5	P11	Øc	N17	N12	N13	N14	N16	N27
	mm	mm	mm	mm	mm	mm	mm	mm	mm	mm	mm	DN/in	DN/in/mm	DN/in	in	in	in
BAX 88	1760	890	890	163	1420	1300	250	1037	495	740	400	1"	125 PN16	125 PN16	1"	1"	1/2"
BAX 128	2064	1038	1038	181	1710	1400	420	1030	494	740	400	1"	125 PN16	125 PN16	1"	1"	1/2"
BAX 200	2380	1210	1210	256	1960	1390	410	1555	552	1160	550	1"	200 PN16	200 PN16	1"	1"	1/2"
BAX 230	2592	1317	1317	266	2170	1480	452	1552	548	1100	600	1"	200 PN16	200 PN16	1"	1"1/4	1/2"
BAX 290	2742	1387	1387	285	2321	2080	733	1552	546	1100	700	1"	250 PN16	250 PN16	1"	1"1/4	1/2"
BAX 350	3052	1602	1602	315	2491	2126	598	1622	546	1100	800	1"	250 PN16	250 PN16	1"	1"1/4	1/2"

ECXV



Energy saving achieved by partial sensible heat recovery of the boiler's flue gas by preheating the feed water;

Exchanger element of flue gas/water, non-condensing type, suitable for methane gas boiler operation, manufactured from finned tubes made from carbon steel P235GH, arranged in several rows with distribution manifolds.

Frame coated hermetic carbon steel frame, directly coupled to the boiler smoke box.

Flue gas outlet fitting conical, flanged, equipped with a top circular flange for chimney connection;

Pipes and headers for instrument assembly and hydraulic connection;

A-type installation diagram

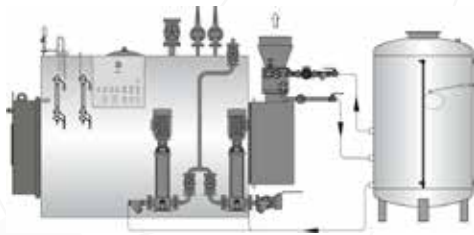

Standard accessories for type A

- Safety valve (3 bar)
- Energy saver circulation pump
- 3 shut-off valves
- 2 water thermometers upstream and downstream of the economiser

B-type installation diagram

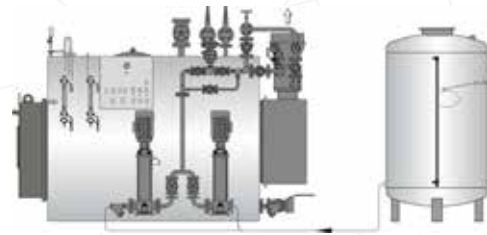

Standard accessories for type B

- PED-certified safety valve (18 bar)
- 3 by-pass and shut-off valves
- Water thermometer downstream of the economiser
- Water pressure gauge downstream of the economiser
- Economiser - boiler connection pipes

MATCHING EQUIPMENT AND TECHNICAL SPECIFICATIONS

Model	Suitable for	INSTALLATION (A)					INSTALLATION (B)				
		Code	Inlet T	Outlet T	Flow rate	Water-side pressure drop	Code	Inlet T	Outlet T	Flow rate	Water-side pressure drop
			°C	°C	l/h	bar		°C	°C	l/h	bar
ECXV 2-6	SIXEN 350	85500090	75	90	891	0,02	85500092	80	112	340	0,006
	SIXEN 500		75	90	1209	0,02		80	110	510	0,013
	SIXEN 650		75	90	1485	0,04		80	108	680	0,02
	SIXEN 800		75	90	1728	0,05		80	106	850	0,04
	SIXEN 1000		75	90	1945	0,06		80	105	1020	0,06
ECXV 8-12	SIXEN 1350	85500120	75	90	2695	0,19	85500110	80	109	1370	0,15
	SIXEN 1700/GX 1000		75	90	3096	0,26		80	107	1700	0,21
	SIXEN 2000/GX 1200		75	90	3555	0,31		80	106	2040	0,29
ECXV 15-20	SIXEN 2500/GX 1500	85500140	75	90	4701	0,13	85500135	80	107	2560	0,03
	SIXEN 3000/GX 1750		75	90	5275	0,15		80	106	3000	0,07
	SIXEN 3500/GX 2000		75	90	5791	0,18		80	105	3400	0,06
ECXV 25-35	SIXEN 4000/GX 2500	85500170	75	90	8141	0,21	85500160	80	108	4270	0,07
	SIXEN 5000/GX 3000		75	90	9231	0,26		80	107	5100	0,09
	GX 3500		75	90	10263	0,37		80	105	6000	0,13
ECXV 40-50	GX 4000	-	Installation (A) not available				85500175	80	114	6820	0,27
	GX 5000		80	113	8500	0,3					
ECXV 60-70	GX 6000	-	Installation (A) not available				85500190	80	113	10240	0,44
	GX 7000		80	111	12000	0,57					
ECXV 80	GX 8000	-	Installation (A) not available				85500220	80	112	13600	0,58
ECXV 90-100	GX 9000	-	Installation (A) not available				85500230	80	112	15300	0,18
	GX 10000		80	111	17000	0,19					
ECXV 120-130	GX 12000	-	Installation (A) not available				85500250	80	111	20000	0,3
	GX 13000		80	110	22000	0,35					
ECXV 150	GX 15000	-	Installation (A) not available				85500260	80	113	25000	0,1

Vertical energy saver

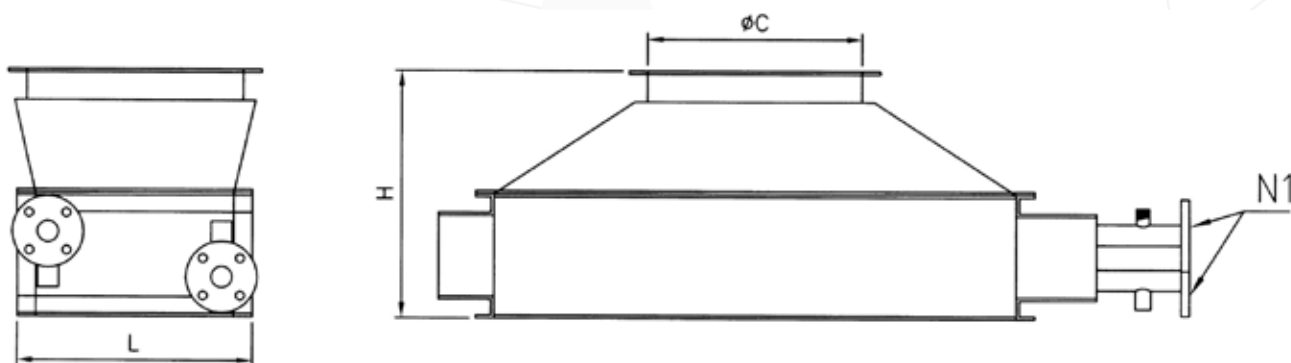

TECHNICAL SPECIFICATIONS AND DIMENSIONS

Model	Suitable for	Heat output	100% efficiency (ref. NCV)	Flue gas pressure drop	Flue gas temperature at boiler output	Weight	Dimensions				
							N1	Ø C	H	L	P
		kW	%	mbar	°C	kg	in/DN	mm	mm	mm	mm
ECXV 2-6	SIXEN 350	15	+ 6,7	0,1	119	85	1"	250	400	278	710
ECXV 2-6	SIXEN 500	21	+ 6,1	0,2	131	85	1"	250	400	278	710
ECXV 2-6	SIXEN 650	25	+ 5,6	0,3	139	85	1"	250	400	278	710
ECXV 2-6	SIXEN 800	30	+ 5,2	0,4	146	85	1"	250	400	278	710
ECXV 2-6	SIXEN 1000	34	+ 4,9	0,5	152	85	1"	250	400	278	710
ECXV 8-12	SIXEN 1350	47	+ 5,0	0,3	149	124	25	350	400	380	910
ECXV 8-12	SIXEN 1700/GX 1000	54	+ 4,7	0,4	155	124	25	350	400	380	910
ECXV 8-12	SIXEN 2000/GX 1200	62	+ 4,4	0,5	160	124	25	350	400	380	910
ECXV 15-20	SIXEN 2500/GX 1500	82	+ 4,7	0,2	155	178	40	450	550	552	1030
ECXV 15-20	SIXEN 3000/GX 1750	92	+ 4,5	0,3	158	178	40	450	550	552	1030
ECXV 15-20	SIXEN 3500/GX 2000	101	+ 4,3	0,4	162	178	40	450	550	552	1030
ECXV 25-35	SIXEN 4000/GX 2500	142	+ 4,9	0,4	152	232	40	550	575	708	1280
ECXV 25-35	SIXEN 5000/GX 3000	161	+ 4,6	0,5	157	232	40	550	575	708	1280
ECXV 25-35	GX 3500	179	+ 4,4	0,7	160	232	40	550	575	708	1280
ECXV 40-50	GX 4000	267	+ 5,7	1,9	135	269	40	650	700	642	1280
ECXV 40-50	GX 5000	315	+ 5,4	2,8	141	269	40	650	700	642	1280
ECXV 60-70	GX 6000	391	+ 5,6	2,3	138	341	50	700	700	732	1480
ECXV 60-70	GX 7000	435	+ 5,3	2,9	143	341	50	700	700	732	1480
ECXV 80	GX 8000	502	+ 5,4	2,8	142	438	50	800	700	822	1530
ECXV 90-100	GX 9000	564	+ 5,4	2,5	142	510	65	900	700	912	1630
ECXV 90-100	GX 10000	606	+ 5,2	3	145	510	65	900	700	912	1630
ECXV 120-130	GX 12000	738	+ 5,2	3	145	591	65	1100	700	912	1980
ECXV 120-130	GX 13000	780	+ 5,1	3,3	146	591	65	1100	700	912	1980
ECXV 150	GX 15000	925	+ 5,2	2,8	144	722	65	1300	700	1002	2280

ECO-G



The economiser for the ECO-G series is built into the rear smoke box of the GSX steam boilers. Opting THE economiser allows you to achieve energy savings thanks to partial sensible heat recovery of the boiler's flue gas by preheating the feed water. Fully removable construction from the rear to aid in boiler maintenance operations.

It consists of:

- flue gas / water exchanger non condensing element suitable for methane gas boiler operation, manufactured from finned tubes made from carbon steel P235GH or stainless steel, arranged in several rows with distribution manifolds; construction in accordance with the Directive PED 2014/68/ EU
- instrument assembly and hydraulic connection headers and pipes

The economiser of the ECO-G series can be supplied in two versions:

- **ECO-G** : with finned pipes in P235GH carbon steel
- **ECO-GN** : with finned pipes in AISI 304 stainless steel

The tables below show the features and codes of the two versions.

A-type installation diagram

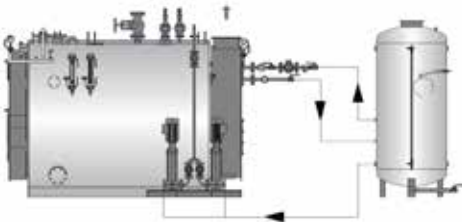

- Standard accessories for type A
- Safety valve (3 bar)
- Energy saver circulation pump
- 3 shut-off valves
- 2 water thermometers upstream and downstream of the economiser

B-type installation diagram

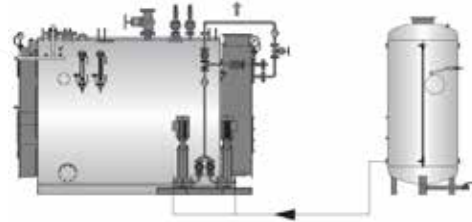

- Standard accessories for type B
- PED-certified safety valve (18 bar)
- 3 by-pass and shut-off valves
- Water thermometer downstream of the economiser
- Water pressure gauge downstream of the economiser
- Economiser - boiler connection pipes

MATCHING EQUIPMENT AND TECHNICAL SPECIFICATIONS

Model	Suitable for	Installation type	Code	Heat output		100% efficiency (ref. NCV)	Max. fluid flow rate	Fluid temp.		Flue gas temp.		Pressure drop	
				kW	kcal/h			%	kg/h	inlet °C	outlet °C	inlet °C	Air nom. pow. = 20°C °C
ECO-G 1	GSX 350 - GSX 500 P	A	85500113_1	12	10.000	+ 4%	684	75	90	220	125-130	0,7	19
	GSX 500 - GSX 650 P	A	85500113_2	16	14.000	+ 4%	908	75	90	220	125-130	0,8	19
	GSX 650 - GSX 850 P	A	85500113_3	20	17.000	+ 4%	1.128	75	90	220	125-130	0,9	17
ECO-G 2	GSX 850 - GSX 1100 P	A	85500114_1	29	25.000	+ 4%	1.662	75	90	220	125-130	0,7	19
	GSX 1100 - GSX 1500 P	A	85500114_2	33	28.000	+ 4%	1.910	75	90	220	125-130	0,9	17
ECO-G 3	GSX 1500 - GSX 2000 P	A	85500112_1	51	44.000	+ 4%	2.931	75	90	220	125-130	0,7	19
	GSX 2000 - GSX 2500 P	A	85500112_2	61	52.000	+ 4%	3.472	75	90	220	125-130	0,9	17
ECO-G 4	GSX 2500 - GSX 3000 P	A	85500115_1	85	73.000	+ 4%	4.884	75	90	220	125-130	0,7	19
	GSX 3000 - GSX 3500 P	A	85500115_2	91	78.000	+ 4%	5.208	75	90	220	125-130	0,9	17
ECO-G 5	GSX 3500 - GSX 4000 P	A	85500116_1	119	102.000	+ 4%	6.837	75	90	220	125-130	0,7	19
	GSX 4000 - GSX 5000 P	A	85500116_2	121	104.000	+ 4%	6.944	75	90	220	125-130	0,9	17
ECO-G 6	GSX 5000 - GSX 6000 P	A	85500117_1	151	130.000	+ 4%	8.683	75	90	220	125-130	0,9	15

Economiser for steam boilers series GSX

MATCHING EQUIPMENT AND TECHNICAL SPECIFICATIONS

Model	Suitable for	Installation type	Code	Heat output		100% efficiency (ref. NCV)	Max. fluid flow rate	Fluid temp.		Flue gas temp.		Pressure drop	
				kW	kcal/h			%	kg/h	inlet	outlet	inlet	Air nom. pow. = 20°C
						°C	°C						
ECO-G 1	GSX 350 - GSX 500 P	B	85500081_1	12	10.000	+ 4%	385	80	107	220	125-130	0,7	6
	GSX 500 - GSX 650 P	B	85500081_2	16	14.000	+ 4%	595	80	105	220	125-130	0,8	7
	GSX 650 - GSX 850 P	B	85500081_3	20	17.000	+ 4%	715	80	104	220	125-130	0,9	7
ECO-G 2	GSX 850 - GSX 1100 P	B	85500082_1	29	25.000	+ 4%	935	80	107	220	125-130	0,7	6
	GSX 1100 - GSX 1500 P	B	85500082_2	33	28.000	+ 4%	1.210	80	104	220	125-130	0,9	7
ECO-G 3	GSX 1500 - GSX 2000 P	B	85500083_1	51	44.000	+ 4%	1.650	80	107	220	125-130	0,7	6
	GSX 2000 - GSX 2500 P	B	85500083_2	61	52.000	+ 4%	2.200	80	104	220	125-130	0,9	7
ECO-G 4	GSX 2500 - GSX 3000 P	B	85500084_1	85	73.000	+ 4%	2.750	80	107	220	125-130	0,7	6
	GSX 3000 - GSX 3500 P	B	85500084_2	91	78.000	+ 4%	3.300	80	104	220	125-130	0,9	7
ECO-G 5	GSX 3500 - GSX 4000 P	B	85500085_1	119	102.000	+ 4%	3.850	80	107	220	125-130	0,7	6
	GSX 4000 - GSX 5000 P	B	85500085_2	121	104.000	+ 4%	4.400	80	104	220	125-130	0,9	7
ECO-G 6	GSX 5000 - GSX 6000 P	B	85500086_1	151	130.000	+ 4%	5.500	80	104	220	125-130	0,9	6

Model	Suitable for	Installation type	Code	Heat output		100% efficiency (ref. NCV)	Max. fluid flow rate	Fluid temp.		Flue gas temp.		Pressure drop	
				kW	kcal/h			%	kg/h	inlet	outlet	inlet	Air nom. pow. = 20°C
						°C	°C						
ECO-GN 1	GSX 350 - GSX 500 P	A	85500061_1	12	10.000	+ 4%	684	75	90	220	125-130	0,7	19
	GSX 500 - GSX 650 P	A	85500061_2	16	14.000	+ 4%	908	75	90	220	125-130	0,8	19
	GSX 650 - GSX 850 P	A	85500061_3	20	17.000	+ 4%	1.128	75	90	220	125-130	0,9	17
ECO-GN 2	GSX 850 - GSX 1100 P	A	85500062_1	29	25.000	+ 4%	1.662	75	90	220	125-130	0,7	19
	GSX 1100 - GSX 1500 P	A	85500062_2	33	28.000	+ 4%	1.910	75	90	220	125-130	0,9	17
ECO-GN 3	GSX 1500 - GSX 2000 P	A	85500063_1	51	44.000	+ 4%	2.931	75	90	220	125-130	0,7	19
	GSX 2000 - GSX 2500 P	A	85500063_2	61	52.000	+ 4%	3.472	75	90	220	125-130	0,9	17
ECO-GN 4	GSX 2500 - GSX 3000 P	A	85500064_1	85	73.000	+ 4%	4.884	75	90	220	125-130	0,7	19
	GSX 3000 - GSX 3500 P	A	85500064_2	91	78.000	+ 4%	5.208	75	90	220	125-130	0,9	17
ECO-GN 5	GSX 3500 - GSX 4000 P	A	85500065_1	119	102.000	+ 4%	6.837	75	90	220	125-130	0,7	19
	GSX 4000 - GSX 5000 P	A	85500065_2	121	104.000	+ 4%	6.944	75	90	220	125-130	0,9	17
ECO-GN 6	GSX 5000 - GSX 6000 P	A	85500066_1	151	130.000	+ 4%	8.683	75	90	220	125-130	0,9	15

Model	Suitable for	Installation type	Code	Heat output		100% efficiency (ref. NCV)	Max. fluid flow rate	Fluid temp.		Flue gas temp.		Pressure drop	
				kW	kcal/h			%	kg/h	inlet	outlet	inlet	Air nom. pow. = 20°C
						°C	°C						
ECO-GN 1	GSX 350 - GSX 500 P	B	85500071_1	12	10.000	+ 4%	385	80	107	220	125-130	0,7	6
	GSX 500 - GSX 650 P	B	85500071_2	16	14.000	+ 4%	595	80	105	220	125-130	0,8	7
	GSX 650 - GSX 850 P	B	85500071_3	20	17.000	+ 4%	715	80	104	220	125-130	0,9	7
ECO-GN 2	GSX 850 - GSX 1100 P	B	85500072_1	29	25.000	+ 4%	935	80	107	220	125-130	0,7	6
	GSX 1100 - GSX 1500 P	B	85500072_2	33	28.000	+ 4%	1.210	80	104	220	125-130	0,9	7
ECO-GN 3	GSX 1500 - GSX 2000 P	B	85500073_1	51	44.000	+ 4%	1.650	80	107	220	125-130	0,7	6
	GSX 2000 - GSX 2500 P	B	85500073_2	61	52.000	+ 4%	2.200	80	104	220	125-130	0,9	7
ECO-GN 4	GSX 2500 - GSX 3000 P	B	85500074_1	85	73.000	+ 4%	2.750	80	107	220	125-130	0,7	6
	GSX 3000 - GSX 3500 P	B	85500074_2	91	78.000	+ 4%	3.300	80	104	220	125-130	0,9	7
ECO-GN 5	GSX 3500 - GSX 4000 P	B	85500075_1	119	102.000	+ 4%	3.850	80	107	220	125-130	0,7	6
	GSX 4000 - GSX 5000 P	B	85500075_2	121	104.000	+ 4%	4.400	80	104	220	125-130	0,9	7
ECO-GN 6	GSX 5000 - GSX 6000 P	B	85500076_1	151	130.000	+ 4%	5.500	80	104	220	125-130	0,9	6

Fin-e®

THE 3-STARS EFFICIENCY SYSTEM PATENTED BY ICI CALDAIE



Fin-e® is a system that increases the boiler efficiency: energy saving reduces environmental impact.

Fin-e® is an aluminium extrusion, with internal fins, inserted in the rear of the boilers' fire tubes in order to guarantee complete contact between surfaces. While flue gas transmits thermal energy along the finned surfaces, its own temperature is reduced before it reaches the smoke box and therefore it exits at the chimney at a very low temperature. The boiler, unchanged in structure, recovers efficiency without increasing the pressure in the furnace (the boiler-burner coupling does not change). The longitudinal layout of the internal fins makes the maintenance operations easier: one brush with similar geometry is enough to remove combustion residues.

Possibility to drain the condensate (cold starting) from the channel present at the bottom of Fin-e®: thanks to Fin-e® open-profile design, any condensate is drained towards the smokebox chamber without affecting the boiler body.

Benefits:

- Increase of efficiency
- Reduction of fuel consumption and CO₂ emissions
- Respect for the environment

Offered service:

- Installation of Fin-e® system by the authorised service centre
- New certification

The Fin-e® system can be applied only using **gaseous fuels.**





Components and accessories to build complete heating plant rooms.

BOILER ROOM ANCILLARIES AREA

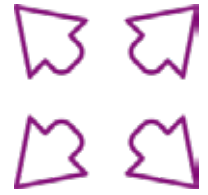

⊕ BOILER ROOM ANCILLARIES

RANGE	VRC	p. 198
	VRC-V	p. 200
	DEG	p. 202
	DEG-P	p. 204
	ADD	p. 206
	BDV	p. 208
	EVX	p. 210
	VEO	p. 212
	VEX	p. 213
	VEA	p. 214
	STORAGE TANK	p. 216
	COV	p. 217

The provided figures and data are for reference only.

ICI CALDAIE SpA reserves the right to apply any modification it deems necessary to improve its products, without prior notice.

VRC

Feed water tank



The condensate collection tank (VRC) has been designed to collect condensate returning from the steam system team and to mix it with the make-up softened or demineralised water. Entirely made of AISI 316 L stainless steel.

Provided with:

- supporting legs
- upper manhole, connections and fittings

Product complete with level float control.

Should it be necessary to use a level control with probes, electric panel and solenoid valve, choose model **VRC-V**

Standard equipment:

- Water replenishment valve with float in STAINLESS steel
- Level indicator
- Drain valve

CODES AND MATCHING BOILERS

Model	Code	BNX	SIXEN	GSX	GSX P	GX
VRC 200	85520046	100 - 150	-	-	-	-
VRC 300	85520048	350	350	350	-	-
VRC 500	85520047	500	500	500	500	-
VRC 800	85520056	700 - 850	650 - 800	650 - 850	650 - 850	-
VRC 1000	85520045	1000	1000	1100	1100	-
VRC 1500	85520070	1400	1350 - 1700	1500	1500	-
VRC 2000	85520054	1700 - 2000	2000	2000	2000 - 2500	1000 - 1200
VRC 2500	85520058	2650	2500	2500	-	1500
VRC 3000	85520053	3000	3000	3000	3000	1750 - 2000
VRC 4000	85520074	-	3500 - 4000	3500 - 4000	3500 - 4000	2500
VRC 5000	85520075	-	5000	5000	5000 - 6000	3000

TECHNICAL DATA

Model	Nominal pressure	TS max. operating temperature	Total volume H2O	Total weight
	bar	°C	lt	kg
VRC 200	0	90	200	32
VRC 300	0	90	300	41
VRC 500	0	90	500	56
VRC 800	0	90	800	71
VRC 1000	0	90	1000	78
VRC 1500	0	90	1500	118
VRC 2000	0	90	2000	150
VRC 2500	0	90	2500	164
VRC 3000	0	90	3000	213
VRC 4000	0	90	4000	278
VRC 5000	0	90	5000	358

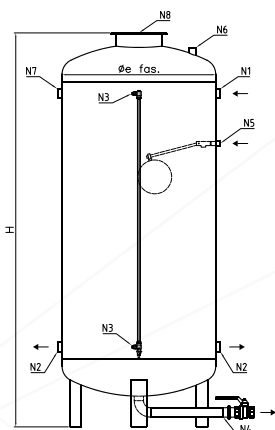

- Key:
- N1 Condensate return inlet from steam using system
 - N2 Boiler supply pump connection fittings
 - N3 Level indicator fittings
 - N4 Drain connection
 - N5 Vessel supply with a float valve connected to water treatment system
 - N6 Atmospheric vent releasing the re-evaporation steam into the environment
 - N7 Overflow drain
 - N8 Hatch

DIMENSIONS

Model	H	OD	N1	N2	N3	N4	N5	N6	N7	N8
	mm	mm	DN/in	DN/in	DN/in	DN/in	DN/in	DN/in	DN/in	DN/in
VRC 200	1420	450	1"1/4	1"1/4	1/2"	1"	1/2"	1"	1"1/4	240
VRC 300	1460	550	1"1/4	1"1/4	1/2"	1"	1/2"	1"	1"1/4	320
VRC 500	1900	600	1"1/4	1"1/4	1/2"	1"	1/2"	1"	1"1/4	320
VRC 800	1870	790	1"1/4	1"1/4	1/2"	1"1/4	1/2"	1"	1"1/4	320
VRC 1000	2140	800	1"1/4	1"1/4	1/2"	1"1/4	1/2"	1"	1"1/4	320
VRC 1500	2140	1000	2"	2"	1/2"	1"1/4	1/2"	1"	2"	400
VRC 2000	2230	1200	2"	2"	1/2"	1"1/4	3/4"	1"	2"	400
VRC 2500	2480	1200	2"	2"	1/2"	1"1/4	3/4"	1"	2"	400
VRC 3000	2750	1250	2"	2"	1/2"	1"1/4	3/4"	1"	2"	400
VRC 4000	2830	1400	2"	2"	1/2"	1"1/4	1"	1"	2"	400
VRC 5000	2860	1600	2"	2"	1/2"	1"1/4	1"	1"	2"	400

VRC-V

Feed water tank



The condensate collection tank (VRC-V) has been designed to collect condensate returning from the steam system team and to mix it with the make-up softened or demineralised water. Entirely made of AISI 316 L stainless steel.

Provided with:

- supporting legs
- upper manhole, connections and fittings

Standard equipment

Make-up feed water unit including:

- Water solenoid valve complete with wiring to the control panel
- Tank internal conveyor tube

Automatic conductivity probe level regulator including:

- Solenoid valve opening probe
- Solenoid valve closing probe
- Probe for alarm and low level signalling
- Probe for alarm and high level signalling
- Glass level indicator

Boiler control panel, IP55 1/N ~ 230V 50 Hz

CODES AND MATCHING BOILERS

Model	Code	BNX	SIXEN	GSX	GSX P	GX
VRC-V 200	85522005	100 - 150	-	-	-	-
VRC-V 300	85522010	350	350	350	-	-
VRC-V 500	85522015	500	500	500	500	-
VRC-V 800	85522020	700 - 850	650 - 800	650 - 850	650 - 850	-
VRC-V 1000	85522025	1000	1000	1100	1100	-
VRC-V 1500	85522030	1400	1350 - 1700	1500	1500	-
VRC-V 2000	85522035	1700 - 2000	2000	2000	2000 - 2500	1000 - 1200
VRC-V 2500	85522040	2650	2500	2500	-	1500
VRC-V 3000	85522045	3000	3000	3000	3000	1750 - 2000
VRC-V 4000	85522050	-	3500 - 4000	3500 - 4000	3500 - 4000	2500
VRC-V 5000	85522055	-	5000	5000	5000 - 6000	3000

TECHNICAL DATA

Model	Nominal pressure	TS max. operating temperature	Total volume H2O	Total weight
	bar	°C	l	kg
VRC-V 200	0	90	200	60
VRC-V 300	0	90	300	75
VRC-V 500	0	90	500	100
VRC-V 800	0	90	800	110
VRC-V 1000	0	90	1000	135
VRC-V 1500	0	90	1500	160
VRC-V 2000	0	90	2000	200
VRC-V 2500	0	90	2500	220
VRC-V 3000	0	90	3000	270
VRC-V 4000	0	90	4000	310
VRC-V 5000	0	90	5000	390

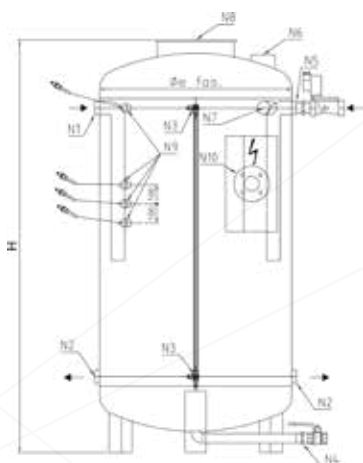

Key:

- N1 Condensate return inlet from steam using system
- N2 Boiler supply pump connection fittings
- N3 Level indicator fittings
- N4 Drain connection
- N5 Vessel supply with make-up valve connected to water treatment system
- N6 Atmospheric vent that directly leads re-evaporation steam into the atmosphere: make sure that tank is always at atmospheric pressure.
- N7 Overflow drain
- N8 Hatch
- N9 Level probe connections
- N10 Control panel support

DIMENSIONS

Model	H	OD	N1	N2	N3	N4	N5	N6	N7	N8	N9	N10
	mm	mm	DN/in	DN/in	DN/in	DN/in	DN/in	DN/in	DN/in	DN/in	DN/in	DN/in
VRC-V 200	1420	450	1"1/4	1"1/4	1/2"	1"	1"1/4	4"	1"1/4	240	1"	65
VRC-V 300	1460	550	1"1/4	1"1/4	1/2"	1"	1"1/4	4"	1"1/4	320	1"	65
VRC-V 500	1900	600	1"1/4	1"1/4	1/2"	1"	1"1/4	4"	1"1/4	320	1"	65
VRC-V 800	1870	790	1"1/4	1"1/4	1/2"	1"1/4	1"1/4	4"	1"1/4	320	1"	65
VRC-V 1000	2140	800	1"1/4	1"1/4	1/2"	1"1/4	1"1/4	4"	1"1/4	320	1"	65
VRC-V 1500	2140	1000	2"	2"	1/2"	1"1/4	2"	4"	2"	400	1"	65
VRC-V 2000	2230	1200	2"	2"	1/2"	1"1/4	2"	4"	2"	400	1"	65
VRC-V 2500	2480	1200	2"	2"	1/2"	1"1/4	2"	4"	2"	400	1"	65
VRC-V 3000	2750	1250	2"	2"	1/2"	1"1/4	2"	4"	2"	400	1"	65
VRC-V 4000	2830	1400	2"	2"	1/2"	1"1/4	2"	4"	2"	400	1"	65
VRC-V 5000	2860	1600	2"	2"	1/2"	1"1/4	2"	4"	2"	400	1"	65

DEG

Atmospheric deaerator



The DEG deaerators are devices at atmospheric pressure designed for the thermophysical degassing of the steam boiler feed water. The degassing process is performed by means of a controlled steam injection inside the storage tank in order to increase the internal water temperature.

This appliance is part of the condition provided by the Art. 3 Par. 3 of the PED Directive 2014/68 / EU.

Provided with:

- steam diffuser pipe inside the tank
- sheet steel support saddles able to ensure unit support
- insulating coating with high density mineral wool and aluminium sheet finish

The deaerator is available in the S235JR steel or AISI 304 stainless steel versions.

Standard equipment:

Thermoregulating unit for temperature maintenance (90°C) in the storage tank including:

- automatic or pneumatic modulating two-way valve
- temperature sensor
- steam filter
- 2 shut-off globe valves
- bypass globe valve

Blowdown unit including:

- bypass globe valve

Make-up feed water unit including:

- water solenoid valve
- water filter
- 2 shut-off ball valves
- bypass ball valve

Automatic conductivity probe level regulator including:

- solenoid valve opening and closing probes
- probe for alarm and low level signalling

Boiler control panel, IP55 1/N ~ 230V 50 Hz

BOILERS THAT CAN BE MATCHED

Model	SIXEN	GSX	GSX P	GX
DEG 500	500	500	500	-
DEG 1000	650 - 800 - 1000	650 - 800 - 1000	650 - 800 - 1000	-
DEG 1500	1350 - 1700	1350 - 1700	1350 - 1700	-
DEG 2000	2000	2000	2000	1200
DEG 2500	2500	2500	2500	1500
DEG 3000	3000	3000	3000	1750 - 2000
DEG 4000	3500 - 4000	3500 - 4000	3500 - 4000	2500
DEG 5000	5000	5000	5000	3000
DEG 8000	-	-	6000	3500 - 4000 - 5000
DEG 10000	-	-	-	6000
DEG 12000	-	-	-	7000
DEG 15000	-	-	-	8000 - 9000
DEG 20000	-	-	-	10000 - 12000
DEG 25000	-	-	-	13000 - 15000

TECHNICAL DATA

Model	Total volume H2O	Deaeration capacity	Steam consumption	Total weight	H	L	P
	lt	l/h	kg/h	kg	mm	mm	mm
DEG 500	500	500	65	280	1100	830	1800
DEG 1000	1000	1000	130	440	1250	1030	2140
DEG 1500	1500	1500	195	500	1250	1030	3040
DEG 2000	2000	2000	260	640	1550	1300	2380
DEG 2500	2500	2500	325	750	1550	1300	2980
DEG 3000	3000	3000	390	850	1800	1480	3060
DEG 4000	4000	4000	520	1050	1950	1630	2940
DEG 5000	5000	5000	650	1100	2150	1830	2880
DEG 8000	8000	8000	1040	1600	2150	1830	4230
DEG 10000	10000	10000	1300	2400	2150	1830	5450
DEG 12000	12000	12000	1560	2600	2377	2130	5028
DEG 15000	15000	15000	1950	3000	2473	2230	5528
DEG 20000	20000	20000	2600	3800	2650	2200	6810
DEG 25000	25000	25000	3250	4200	2550	2100	9050

The values indicated in the table are referred to both DEG and DEG STAINLESS STEEL types

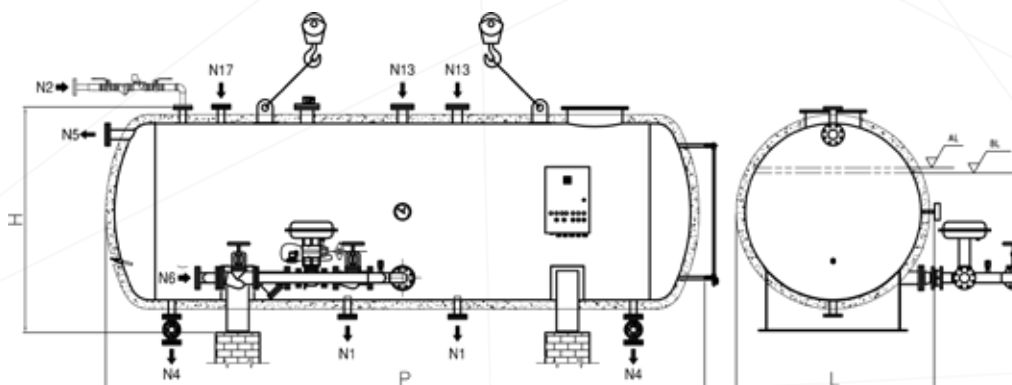

PRODUCT CODES

Model	Code
DEG 500	85500015
DEG 1000	85500012
DEG 1500	85500026
DEG 2000	85500028
DEG 2500	85500025
DEG 3000	85500005
DEG 4000	85500014
DEG 5000	85500016
DEG 8000	85500018
DEG 10000	85500022
DEG 12000	85500031
DEG 15000	85500037
DEG 20000	85500043
DEG 25000	85500021

Model	Code
DEG 500 INOX	85500300
DEG 1000 INOX	85500044
DEG 1500 INOX	85500046
DEG 2000 INOX	85500035
DEG 2500 INOX	85500302
DEG 3000 INOX	85500304
DEG 4000 INOX	85500306
DEG 5000 INOX	85500032
DEG 8000 INOX	85500310
DEG 10000 INOX	85500312
DEG 12000 INOX	85500036
DEG 15000 INOX	85500314
DEG 20000 INOX	85500315
DEG 25000 INOX	85500316

DEG/P

Atmospheric deaerator



The DEG P pressurised thermophysical deaerator collects the treated make-up water delivered by a suitable treatment system.

The make-up water is controlled by a pneumatic, modulating 2-way valve that receives the signal from the level regulator/indicator positioned on the horizontal tank.

The water is atomized at the top of the degassing tower and falls into circular plates suitably perforated through which the heating steam passes.

On the top part of the turret there is also a fitting for possible system condensate returns and a manual oxygen blowdown valve.

This appliance has a design pressure of 0.5 bar and therefore it is not subject to the provisions of the PED Directive 2014/68/EU.

Provided with:

- vertical degassing turret, manufactured from C steel (stainless steel AISI 304 version also available) flanged to the lower reservoir with stainless steel AISI 304 jagged internal plates
- sheet steel support saddles able to ensure unit support
- insulating coating with high density mineral wool and aluminium sheet finish

Standard equipment:

Steam regulation unit to maintain the temperature (105°C) in the storage tank including:

- steam regulation modulating valve of the automatic or pneumatic type
- by-pass and shut-off valves
- steam filter
- appropriate steam injectors
- temperature probe

Steam regulation unit to maintain the correct pressure value (0.2-0.4 bar) in the degassing turret including:

- steam regulation modulating valve of the automatic or pneumatic type
- by-pass and shut-off valves
- steam filter
- appropriate steam injectors
- pressure transducer

Water regulation unit to control the level in the storage tank including:

- feed water solenoid valve
- by-pass and shut-off valves
- water filter
- level regulator with probes
- level indicator
- thermometer
- drain valve
- safety valve
- vacuum relief valve

Boiler control panel, IP55 1/N ~ 230V 50 Hz

PRODUCT CODES

Model	Code
DEG 1000/P	85500323
DEG 2000/P	85500325
DEG 3000/P	85500320
DEG 5000/P	85500401
DEG 8000/P	85500038
DEG 15000/P	85500039
DEG 25000/P	85500047
DEG 30000/P	85500045
DEG 40000/P	85500048
DEG 50000/P	85500034

Model	Code
DEG 1000/P AISI304	85500319
DEG 2000/P AISI304	85500327
DEG 3000/P AISI304	8500322
DEG 5000/P AISI304	85500402
DEG 8000/P AISI304	85500052
DEG 15000/P AISI304	85500054
DEG 25000/P AISI304	85500056
DEG 30000/P AISI304	85500057
DEG 40000/P AISI304	85500058
DEG 50000/P AISI304	85500059

TECHNICAL DATA

Model	Nominal pressure	Design temperature	Total volume H2O	Deaeration capacity	Steam consumption	Total weight
	bar	°C	lt	l/h	kg/h	kg
DEG 1000/P	0,5	110	1000	1000	180	450
DEG 2000/P	0,5	110	2000	2000	360	700
DEG 3000/P	0,5	110	3000	4500	810	980
DEG 5000/P	0,5	110	5000	7500	1350	1280
DEG 8000/P	0,5	110	8000	12000	2160	2500
DEG 15000/P	0,5	110	15000	22500	4050	3800
DEG 25000/P	0,5	110	25000	37500	6750	5250
DEG 30000/P	0,5	110	30000	45000	8100	6550
DEG 40000/P	0,5	110	40000	60000	10800	8000
DEG 50000/P	0,5	110	50000	75000	13500	9900

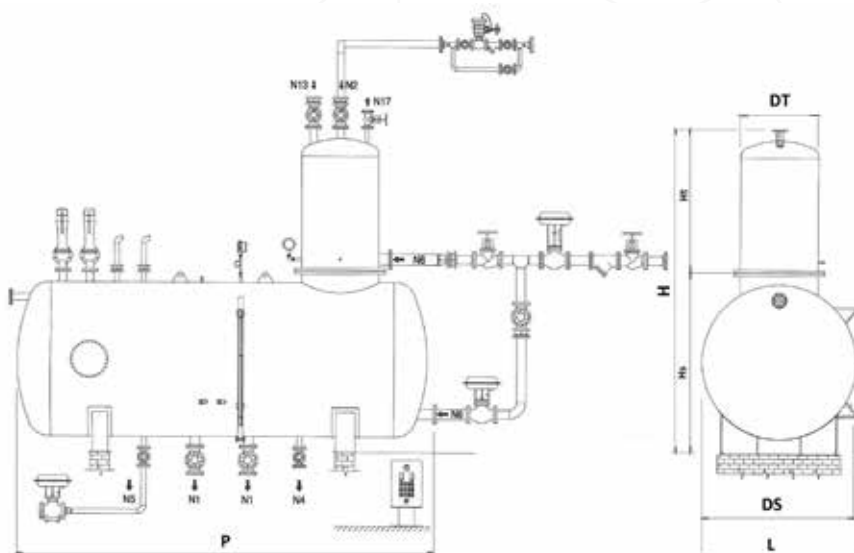

DIMENSIONS

Model	H	HS	Ht	L	DS	Dt	P	N1	N2	N4	N5	N6	N13	N17
	mm	mm	mm	mm	mm	mm	mm	DN/in	DN/in	DN/in	DN/in	DN/in	DN/in	DN/in
DEG 1000/P	2500	1400	1100	1030	950	350	2140	40	25	50	1"1/4	40	40	2"
DEG 2000/P	2800	1550	1250	1300	1100	400	2380	40	25	50	1"1/4	40	40	2"
DEG 3000/P	3050	1550	1500	1600	1460	400	2720	40	25	50	1"1/4	40	40	2"
DEG 5000/P	3350	1590	1760	1410	1250	800	4550	40	32	50	50	50	80	2"
DEG 8000/P	3750	1950	1800	1760	1600	800	4450	80	32	50	50	100	80	50
DEG 15000/P	4250	2350	1900	2160	2000	1000	5400	100	32	50	50	125/100	80	40
DEG 25000/P	5300	2600	2700	2360	2200	1400	7000	100	32	50	100	125	125	65
DEG 30000/P	5550	2750	2800	2500	2340	1600	7250	100	80	50	100	125	125	65
DEG 40000/P	5900	2800	3100	2550	2390	1800	9300	125	100	50	100	150	125	65
DEG 50000/P	6000	2800	3200	2550	2390	2000	11400	125	100	50	100	250	150	65

ADD

Feed water treatment unit for steam boilers



Automatic system for the treatment of steam boiler make-up water, designed to prevent scale deposits and corrosion caused by dissolved gases. The treatment includes a softening process by means of ion-exchange resins and the chemical elimination of oxygen by dosing a conditioning product. All materials are non-toxic and suitable for contact with drinkable water. The softener automatic control system uses the pulsed output from the flow meter to determine the required operations as per the following logic. The regeneration is started when reaching a certain set volume of supplied water. During the regeneration phase, untreated water does not pass forwards to the system.

ADD version

- the regeneration is started when reaching a certain set volume of supplied water. During the regeneration phase, untreated water does not pass forwards to the system.

ADD D version

- The softener consists of two columns that alternate between regeneration and duty. When one chamber is in duty the other regenerates and then goes into standby mode, allowing a the constant supply of treated water without interruptions.

Standard equipment:

- ADD / ADD D softener unit consisting of:
- Resin filter
- Resin chamber in plastic reinforced by fibreglass complete with ion-exchange resin beads, head with diaphragm valves and electronic programming (2 columns for the ADD D version)
- Brine tank of suitable capacity
- Meter with pulse output head

SELECTION TABLE

Selection table	Operation 8÷12 hours a day						Operation 16÷24 hours a day					
	Hardness ≤ 30 °F			Hardness 30÷ 50 °F			Hardness ≤ 30 °F			Hardness 30÷ 50 °F		
Boiler capacity	Condensate return			Condensate return			Condensate return			Condensate return		
kg/h	30%	50%	80%	30%	50%	80%	30%	50%	80%	30%	50%	80%
100÷1020	D	C	A	E	D	C	BB	BB	AA	DD	CC	AA
1370÷2040	F	E	B	H	F	D	DD	DD	AA	FF	EE	BB
2560÷3000	G	F	D	I	H	E	EE	DD	BB	GG	FF	DD
3400÷5100	I	H	E	J	J	F	GG	FF	DD	II	HH	EE
6000÷6820	J	I	F	K	J	H	HH	GG	DD	JJ	II	FF
8500÷10240	K	J	G	L	K	I	JJ	II	FF	KK	JJ	GG

SELECTION TABLE

Se-lect.	Model (single)	Codes	Se-lect.	Model (du-plex)	Codes	Hydraulic conn.	Maximum flow rate	Resins per column	Cycles per column
						in	m ³ /h	l	m ³ °F
A =	ADD 90	ADDNM0007	AA =	ADD 90 D	ADDND0005	1"	1,6	15	90
B =	ADD 150	ADDNM0003	BB =	ADD 150 D	ADDND0006	1"	2,4	25	150
C =	ADD 210	ADDNM0001	CC =	ADD 210 D	ADDND0002	1"	2,8	35	210
D =	ADD 300	ADDNM0006	DD =	ADD 300 D	ADDND0007	1"	3,2	50	300
E =	ADD 450	ADDNM0008	EE =	ADD 450 D	ADDND0001	1"	4,1	75	450
F =	ADD 600	ADDNM0004	FF =	ADD 600 D	ADDND0003	1"	4,5	100	600
G =	ADD 800	ADDNM0009	GG =	ADD 800 D	ADDND0008	1½"	5	130	800
H =	ADD 1050	ADDNM0002	HH =	ADD 1055 D	ADDND0009	1½"	8	175	1050
I =	ADD 1350	ADDNM0010	II =	ADD 1355 D	ADDND0010	1½"	11,5	225	1350
J =	ADD 1950	ADDNM0011	JJ =	ADD 1955 D	ADDND0011	2"	16	325	1950
K =	ADD 3000	ADDNM0012	KK =	ADD 3000 D	ADDND0012	2"	18	500	3000
L =	ADD 4300	ADDNM0013	LL =	ADD 4300 D	ADDND0013	2"	20	725	4300

On request:

DS dosing station composed of:
 Electronic dosing pump
 Product storage tank of adequate capacity
 Meter with pulse output head
 Magnetic level switch for pump stop at empty tank
 25 kg non-volatile de-oxygenating product pack

Table for matching Softeners and DS Dosing Stations

Selection of ADD	Selection of ADD D	Model	Code
A ÷ F =	AA ÷ FF =	DS 1	ADDNV0001
G =	GG =	DS 2	ADDNV0003
H ÷ J =	HH ÷ II =	DS 3	ADDNV0004
K ÷ L =	JJ ÷ LL =	DS 4	ADDNV0005

BDV

Blowdown vessel



The BDV blowdown vessel has been designed to receive sludge that usually settle at the bottom of the steam boilers which is discharged during a bottom blowdown operation; this sludge is cooled and allowed to settle at the bottom of the tank before being discharged to the sewer thus limiting any risks for the operator and damage to the environment.

The blowdown vessel complies with the PED Directive 2014/68/EU

Provided with:

- steel sheet supporting legs
- connections and fittings

Standard equipment

- Drain valve
- Cooling system by means of solenoid valve and thermostat

BOILERS THAT CAN BE MATCHED

Model	FX	FX DUAL	BNX	SIXEN	GSX	GSX P	GX
BDV 50	50 - 100 - 150	100 - 200 - 300	100 - 1700	350 - 1700	350 - 1500	500 - 1500	-
BDV 100	-	-	2000 - 3000	2000 - 5000	2000 - 5000	2000 - 5000	1000 - 3000
BDV 200	-	-	-	-	-	6000	3500 - 12000

PRODUCT CODES

Model	Code	Nominal pressure	Total volume H2O	Total weight
		bar	lt	kg.
BDV 50	85520064	12	500	250
BDV 100	85520085	12	1000	350
BDV 200	85520202	12	2000	650

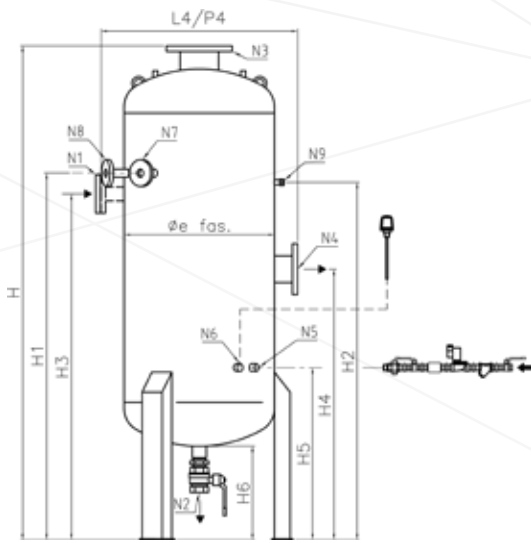

- Key:
- N1 Blowdown inlet
 - N2 Drainage
 - N3 Atmospheric vent
 - N4 Overflow
 - N5 Cooling system
 - N6 Thermostat
 - N7 Boiler level indicator blowdown connections
 - N8 Boiler salinity blowdown connection
 - N9 Manometer

DIMENSIONS

BDV	H	H1	H2	H3	H4	H5	H6	L4	P4	OD	N1	N2	N3	N4	N5	N6	N7	N8	N9
	mm	mm	mm	mm	mm	mm	mm	mm	mm	mm	DN/ in	DN/ in	DN/ in	DN/ in	DN/ in	DN/ in	DN/ in	DN/ in	DN/ in
50	2174	1580	1540	1490	1165	740	400	934	934	650	50	2"	150	100	3/4"	3/4"	25	25	1/2"
100	2774	2130	2090	2040	1215	790	400	1082	1082	800	50	2"	150	100	3/4"	3/4"	25	25	1/2"
200	2934	2210	2170	2120	1295	870	400	1382	1382	1100	50	2"	150	100	3/4"	1"	25	25	1/2"

EVX

Indirect steam boiler



Design pressure 12 (15 bar upon request)

The EVX-series steam boilers are horizontal semi-fixed boilers provided with an exchange coil containing a primary fluid such as thermal oil or super-heated water, complete with regulation and safety accessories.

Provided with:

- sheet steel support saddles and section bar support base.
- insulating coating with high density mineral wool and aluminium sheet finish.

Standard equipment

Steam-side accessory unit including:

- Steam outlet/crown valve
- 2 spring safety valves
- 2 reflex level indicator gauges
- 2 indicator drain and shut-off valve units

Pressure monitoring instrumentation manifold including:

- Large dial 3 way test valve manometer
- Limit pressure switch
- Manual reset safety pressure switch

Automatic conductivity probe level regulator including:

- Pump start probe
- Pump stop probe
- Probe for low level

Blowdown unit including:

- Purge shut-off valve
- Quick exhaust valve with manual lever

Feed water unit mounted on support including:

- 1 vertical multistage centrifugal pumps suitable for 120°C water
- 1 shut-off globe valve
- 1 pump suction filter
- 2 non-return valves

Boiler control panel, IP 55 400V/3 +N/ 50Hz

CODES AND TECHNICAL DATA

Model	Code	Heat output		Steam prod. kg/h	Min.-max. operating pressure bar	Volume level H2O l	Total volume H2O l	Total weight kg
		kW	kcal/h					
EVX 200	87140212	233	200.000	341	8-11,5	481	650	600
EVX 300	87140312	349	300.000	512	8-11,5	592	750	850
EVX 400	87140412	465	400.000	680	8-11,5	960	1270	1000
EVX 500	87140512	581	500.000	855	8-11,5	962	1300	1150
EVX 600	87140612	698	600.000	1024	8-11,5	1295	1750	1350
EVX 800	87140812	930	800.000	1370	8-11,5	1517	2035	1550
EVX 1000	87141012	1163	1.000.000	1710	8-11,5	2070	2710	1700
EVX 1200	87141212	1395	1.200.000	2050	8-11,5	2220	2915	1850
EVX 1500	87141512	1744	1.500.000	2560	8-11,5	2916	3170	2400
EVX 2000	87142012	2326	2.000.000	3400	8-11,5	3384	3775	2550
EVX 2500	87142512	2907	2.500.000	4250	8-11,5	3390	4450	3000
EVX 3000	87143012	3488	3.000.000	5100	8-11,5	3960	5500	3400
EVX 4000	87144012	4651	4.000.000	6820	8-11,5	4680	6500	3800
EVX 5000	87145012	5814	5.000.000	8500	8-11,5	5760	8000	4500
EVX 6000	87146012	6977	6.000.000	10000	8-11,5	7776	10800	5500
EVX 8000	87148012	9302	8.000.000	13600	8-11,5	8856	12300	7200
EVX 9000	87149012	10465	9.000.000	15300	8-11,5	11870	15450	9000

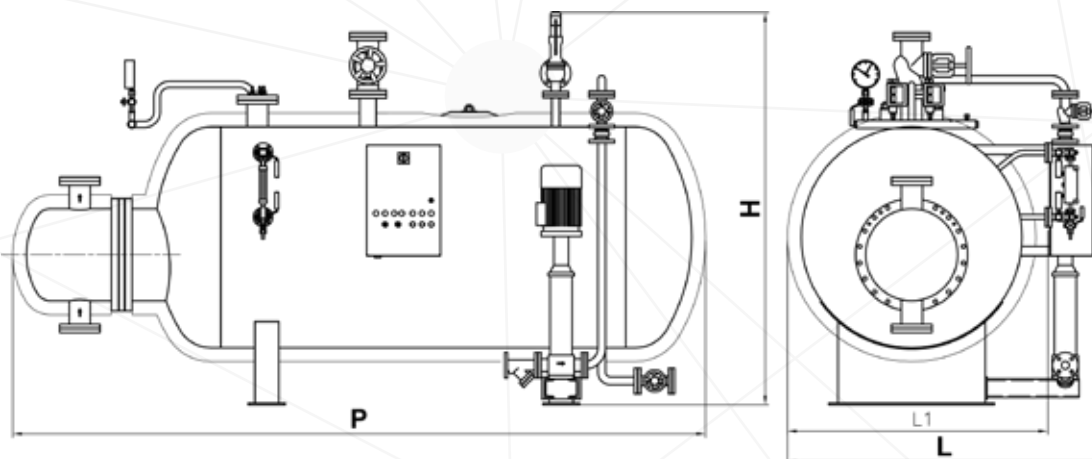

DIMENSIONS

Model	H	L	L1	P
	mm	mm	mm	mm
EVX 200	1450	1300	900	2000
EVX 300	1500	1350	950	2200
EVX 400	1600	1400	1000	2400
EVX 500	1700	1500	1100	2700
EVX 600	1850	1650	1250	3000
EVX 800	1850	1650	1250	3500
EVX 1000	2000	1750	1350	3600
EVX 1200	2000	1750	1350	3800
EVX 1500	2250	1950	1550	3800
EVX 2000	2250	1950	1550	3800
EVX 2500	2300	2050	1550	4300
EVX 3000	2400	2150	1650	4500
EVX 4000	2500	2250	1750	4600
EVX 5000	2650	2350	1850	4900
EVX 6000	2800	2500	2000	5900
EVX 8000	3000	2650	2150	6300
EVX 9000	3325	2790	2290	6415

Thermoregulating unit (REG) for controlling and setting the evaporator output pressure
 Hydraulic connections between the EVX indirect steam boiler and the relevant boiler

VEX

Steam accumulator



Design pressure 5 or 12 bar

The VEX series steam accumulators are semi-fixed, horizontal, complete with accessories.

Our accumulator receives steam from a boiler, therefore it has no internal coil for heat exchange. During normal operation a portion of the steam condenses; therefore, when running, the steam accumulator is partially filled with water.

If the steam demand exceeds the boiler maximum flow, a portion of the water inside the accumulator evaporates making up for the high instantaneous steam demand.

The VEX steam accumulator complies with the PED Directive 2014/68/EU.

Provided with:

- steam diffuser pipe inside the tank
- sheet steel support saddles able to ensure unit support
- insulating coating with high density mineral wool and aluminium sheet finish

Standard equipment

- 1 Manometer
- 1 Level indicator
- 1 Steam trap on overflow fitting

Blowdown unit including:

- 1 Rapid discharge valve with manual lever
- 1 Shut-off valve

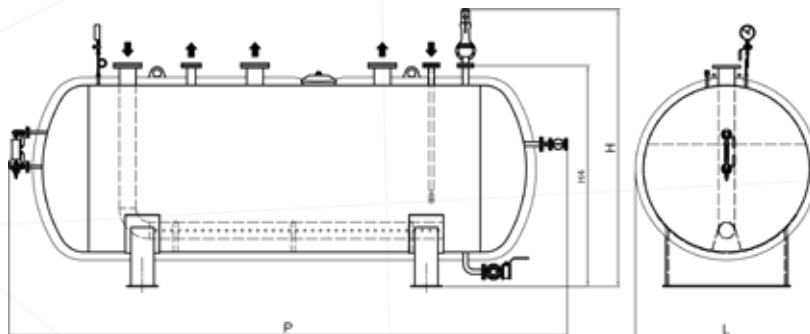

CODES, TECHNICAL SPECIFICATIONS AND DIMENSIONS

Model	Code	Design pressure bar	Total capacity lt	Volume level lt	Total weight kg	H mm	H4 mm	L mm	P mm
VEX 5000	85500104	5	5000	3450	1500	2533	1960	1610	3500
VEX 10000	85500001	5	10000	6860	2200	2823	2250	1860	5700
VEX 15000	85500013	5	15000	7500	3800	2920	2400	2050	6715
VEX 20000	85500049	5	20000	10000	6100	3073	2500	2150	7360
VEX 30000	85500033	5	30000	15000	6800	3373	2800	2400	8700
VEX 5000	85500006	12	5000	3450	1650	2533	1960	1610	3500
VEX 10000	85500011	12	10000	6860	2420	2823	2250	1860	5700
VEX 15000	85500019	12	15000	7500	4180	2920	2400	2050	6715
VEX 20000	85500010	12	20000	10000	6710	3073	2500	2150	7360
VEX 30000	85500101	12	30000	15000	7480	3373	2800	2400	8700

COV

Distribution header



Distribution headers are designed to allow economic distribution of the media (steam, water, thermal oil) to the individual users.

The Distribution headers are individually designed to match the system requirements using ASTM A 106 Gr.B pipe with dished ends, and a sufficient number of flanged fittings suitably sized to match the customer's requirements.

Steam headers are also provided with a dirt leg.

External paint finish for insulation and coating purposes, undertaken on site by the customer.

Wall fixing brackets or floor support saddles are available upon request. COV headers are manufactured and tested with procedures approved according to the PED Directive 2014/68/EU.

Diameter, length and connections are designed according to the customer's requirements specified in the enquiry.

Benefits:

- Reduction of installation costs owing to use of prefabricated elements
- Space saving
- PED 2014/68/EU certification included, according to the requested category



Highly-qualified services capable of meeting the requirements of the the heat and energy saving fields.

SERVICE AREA



⊕ SERVICES

p.

The provided figures and data are for reference only.

ICI CALDAIE SpA reserves the right to apply any modification it deems necessary to improve its products, without prior notice.



INDUSTRIAL AREA

The services on this page are available for:

Industrial start-up

The start-up assistance of an industrial line boiler (steam, super-heated water and waste-heat boilers) is divided into the following categories.

- Start-up assistance of boilers without GSS
- Start-up assistance of boilers with GSS24/GSS 72 module B+D
- Hot functional test of boilers with GSS24/GSS 72 module F
- Industrial start-up assistance abroad
- Industrial start-up assistance with performance test

Start-up assistance of boilers without GSS

The start-up assistance of a boiler without GSS is provided by specialised technicians of ICI Caldaie or authorised service centres at the customer's heating plant room.

During the start-up, the presence of a technician is not compulsory, but it is very useful as a training occasion for the maintenance technician.

With regard to boilers installed in Italy, the only obligation of the customer is the request of the boiler commissioning to the competent INAIL office as per Ministerial Decree No. 329 of 1 December 2004.

Start-up assistance of boilers with GSS24/GSS72

The start-up assistance of a boiler with GSS 24/72 is provided by specialised technicians of ICI Caldaie or authorised service centres at the customer's heating plant room.

During the start-up, the presence of qualified technicians is very useful as a training occasion.

Boilers with GSS 24/72 are supplied by ICI Caldaie already certified according to modules B+D as per PED Directive 2014/68/EU. With regard to boilers installed in Italy, the only obligation of the customer is the request of the boiler commissioning to the competent INAIL office as per Ministerial Decree No. 329 of 1 December 2004.

Hot functional test of boilers with GSS24/GSS 72 module F

The assembly test of a boiler with GSS 24/72 can be performed in the presence of an appointed Notified Body at the ICI Caldaie facilities or customer's heating plant room.

If the assembly test is performed at the ICI Caldaie facilities, the presence of a technician, after the installation of a boiler, is not compulsory, but it is useful as a training occasion for the maintenance technician.

Boilers with GSS 24/72 are certified by ICI Caldaie according to modules B+D as per PED Directive 2014/68/EU. The customer does not have to request the commissioning since the product is compliant with art. 5, letter D of the Ministerial Decree No. 329 of 1 December 2004. The only obligation of the customer is to notify boiler commissioning to the competent INAIL office.

Industrial start-up assistance abroad

Assistance activities during start-up will be carried out by an Italian technician appointed by ICI CALDAIE, who does not own licences or local permits to operate on steam generators.

During assistance activities the customer will have to ensure the presence of personnel authorised to operate on the above-mentioned boilers.

The activity will only have technical-functional valence but not regulatory valence.

The technician in charge cannot sign the documents having this kind of valence.

The start-up of the burner is not included, and will have to be carried out by the local service centre authorised by the manufacturer of the burner and appointed directly by the customer.

The burner technician will have to be present during the carrying out of all the assistance activities performed by the ICI CALDAIE technician.

Start-up Assistance with performance test

The performance test is performed by specialised technicians of ICI Caldaie or authorised service centres at the customer's heating plant room. It involves testing of noise and/or efficiency and/or performance values agreed at the time of sale.



INDUSTRIAL AREA

The services on this page are available for:

Preventive maintenance of steam, superheated water and WHB boilers

The customer can at any time sign with ICI an ordinary maintenance agreement that, thanks to the scheduled inspections, guarantees the boiler control and the purchased product trouble-free operation over time. The preventive maintenance requires an annual inspection by our authorised Technical Service Centres (CAT) including the following operations:

- Cleaning and visually checking the level probes
- Checking the instrument train
- Checking the safety device operation
- Checking the flue gas side
- Checking the supply pump operation through the sight glasses
- Checking the seals for any leak and replacing them if needed (material not included)
- Checking the turbulator conditions (if any)
- Checking the main control panel
- Checking the boiler functionality
- Checking the access door internal coating

Requalification of the boilers to avoid constant surveillance for 72 or 24 hours

The steam and super-heated water boilers, during their operation in a heating plant room, must be monitored by duly authorised control personnel. ICI Caldaie offers the possibility of requalification of said boilers and to extend such obligation to 72 or 24 hours by installing a Global Safety System (GSS72 or GSS24) for steam and super-heated water boilers; this system allows leaving the operating heating plant room “unattended” for maximum 72 or 24 operating hours. Such operation has a variable cost according to the accessories already present in the boiler.

Retubing Boilers

The service involves the replacement of the fire tubes of boilers by ICI Caldaie or third parties, where the presence of leaks was ascertained. The job involves the mechanical removal of the broken tube and subsequent replacement involving welding. Upon each step of the procedure, the necessary non-destructive tests required by law will be carried out to ensure the success of the work.



INDUSTRIAL AREA



RESIDENTIAL AREA

The services on this page are available for:

Warranty extension

ICI Caldaie allows extending the commercial warranty according to the selected duration, starting from the delivery date. The base warranty extension provides only the warranty extension.

No warranty is provided if the damage is caused by:

- improper or unsuitable use
- installation or first start-up performed by the purchaser or third parties in a wrong way
- use or presence of chemical substances, electro-chemical or electric flow, not due to us
- failure to comply with the instructions provided in the user manual, improper changes or modifications, in any case performed by the purchaser or third parties
- faults of the elements not supplied by ICI Caldaie
- aggressive or halogen vapours in the environment (combustion air)
- corrosion due to oxygen
- presence of limestone
- use of the product even if faulty
- wrong electric power supply or connections
- pressure or gas type different from the ones specified for the product

Warranty application is granted by ICI CALDAIE SPA and is subjected to standard conditions of sale shown in the PRODUCT CATALOGUE.

WARRANTY

Any faults detected must be reported immediately by registered letter sent to ICI CALDAIE which reserves the right to carry out an inspection using its own personnel (direct or appointed) at the heating plant room where the problem has arisen. The part to be tested must be sent, carriage paid, to the ICI CALDAIE SPA Service to be examined. Only after this inspection, it will be possible to establish whether the fault is due to faulty material and/or manufacture, or whether it is due to an external cause. After this verification, the customer will be informed of whether or not the fault is covered by the warranty.

Furthermore, the water circulating in the system must be analysed 2 or 3 weeks after the boiler has started operation. This analysis is to be carried out by the installing company which will also bear the relative costs and the results must be attached to the plant register and communicated to ICI Caldaie within two months following the start-up of the boiler. The analysis must comply with the characteristics identified in technical manuals.

The warranty will cover only the defective part; any other expense, for example labour used for the replacement, will be charged to the person requesting the replacement.

The services on this page are available for:



INDUSTRIAL AREA



RESIDENTIAL AREA

Warranty extension

WARRANTY LIMITATIONS

Defects due to different causes not resulting from manufacturing defects are excluded from this warranty, and in particular:

- Tampering or improper adjustment of the boiler performed by the purchaser or third parties who are not part of the network of authorised Technical Assistance Centres on behalf of ICI CALDAIE SPA.
- Conditions of use not envisaged in the instructions and warnings provided on the instruction booklets of ICI CALDAIE SPA supplied with the boiler.
- Use of non-original ICI CALDAIE SPA spare parts.
- System faults, installation errors or non-conformity of the system in relation to the instructions, warnings, Laws, Regulations and applicable Technical Standards (for example: incorrect regulation, boiler supplied with incorrect gas or electrical power, use outside of the boiler type-approval field).
- Absence of exchanger between the primary circuit and the secondary one.
- Thermal shocks due for example to sudden and continuous filling of cold water into the system.
- In the event of operation with pressure below or exceeding the pressure indicated on the data plate of the boiler.
- In the event of clogging from limestone, deposits and sludge, presence of corrosion, overheating of the boiler body.
- No water in the system.
- Use of a fuel other than the indicated one to supply the boiler.
- In the case of inappropriate installations, operation or maintenance which cause damage to the boiler installed, for example poor regulation of the burner, absence of the safety elements required by current Regulations such as safety valves or suitable expansion system, or inappropriate chemical cleaning of the system.
- Use of an unsuitable product for treating the water in the system or an anti-freeze which is incompatible with the construction materials of the system.
- Failure to remove the processing waste and residues in the case of new system or removal of sludge and subsequent cleaning in pre-existing system. In both cases, the operations recommended must be carried out before the boiler of ICI CALDAIE SPA is assembled.
- Wrongful or negligent behaviour, attributable to a seller or other person unrelated to ICI CALDAIE SPA, during the transportation, handling, storage, assembly, installation and adjustment of the boiler.
- The warranty extension only refers to the boiler and excludes the accessories and materials used for the construction of the system and electrical parts.
- Failure to perform the ordinary maintenance as required by current regulations in force for the type of system and as required by the product user manual.
- Events of force majeure (for example: lightning, floods, earthquakes) or vandalism.
- Normal wear of parts (electrodes, refractory products, gaskets, knobs, indicator lights...).

Any technical assistance required to eliminate defects or faults attributable to one of the exclusion causes indicated above must be agreed separately from this Warranty and all related charges and costs will be charged to the applicant according to the price list in force of ICI Caldaie.

The ICI CALDAIE SPA warranty on the manufactured products is limited to the replacement or repair of parts of the boiler identified as being faulty and it does not extend to the repair of other materials present in the system or damage which could be caused or be related to, directly or indirectly, with the faulty part, and not even if the faulty part, or part of it, is unavailable.



INDUSTRIAL AREA



RESIDENTIAL AREA

The services on this page are available for:

Assistance for positioning and/or accessory assembly

This service includes the assistance by one of our specialised technicians during the positioning phases of the boiler in the heating plant room or during the accessory installation in the boiler.

Accessory assembly

The service includes the assembly of the accessories to the boiler once the latter is positioned in the plant room. In this case, for transport reasons, for the boiler introduction in the plant room, or because of specific needs of the customer, the accessories are installed only once the boiler is in its final position.

The following are excluded:

- Connection to the control panel and cable ducts
- Hydraulic connections to the system
- Any building and civil works
- Any crane, platforms and machinery for handling rental

Synoptic diagram

ICI Caldaie can set up a synoptic diagram for all boiler panels already connected to the Internet, allowing the remote reading and management of the systems. The dedicated web page or pages will be created based on the supplied plant layout. The synoptic diagram will be available to be viewed on any PC, tablet or Smartphone connected to the Internet (with compatible browser). For a demo, visit the website <http://www.eterm.it/ita/sinottico/lista> by entering MCE2016 as username and password.

Operation

- Saving the log data.
- Exporting the log data in tables.
- Displaying of log data on graphs (histograms, lines, pie charts, etc.). It is also possible to have more variables on a same graph or graphs of variables that cannot be measured directly but need to be calculated with mathematical formulas.
- Checking the functionality of the panel and accessories connected to it.
- Personalised alarms.
- E-mail service activation for configured alarms.
- Possibility to request one year of remote service for configuration checks and changes.

Flue gas analysis

This service includes the combustion analysis using a certified instrument; at the end of the analysis, the plant register is filled in.

Welding

We can provide assistance for repairs and/or modifications on the boilers using professional and qualified wire, electrode and TIG welders.

This service can be combined with non-destructive tests in case the repairs or changes are requested or have to be performed with the presence of third-party supervisors.

The services on this page are available for:



INDUSTRIAL AREA



RESIDENTIAL AREA

Endoscopy

Our technicians can perform endoscopic visits on ICI products in order to detect any sludge deposit or scale build-ups that can be found on the internal surfaces over time thus reducing the efficiency and performance of the boilers and leading to possible failure. We always recommend a suitable water treatment to avoid the formation of deposits and build-ups.

Burner start-up

In Italy, the start-up of the burner is normally included in the burner price whereas abroad is to be listed separately depending on the country of destination of the parts.

Maintenance of hot water and WHC boiler

The customer can at any time sign with ICI an ordinary maintenance agreement that, thanks to the scheduled inspections, guarantees the boiler control and the purchased product trouble-free operation over time. The preventive maintenance requires an annual inspection by our authorised Technical Service Centres (CAT) including the following operations:

- Visual inspection of the flue gas side;
- Checking the turbulator conditions (if any);
- Checking the main control panel;
- Inspection of the boiler insulation;
- Inspection of the gate operation (only for WHC boilers).

Software license Eterm™

Eterm™PCmanager is a Windows software for PC that allows the configuration and remote control of all Eterm™ and Nereix equipment. This software can be connected to the equipment by means of:

- Direct USB connection to all equipment;
- RS232 (serial port) direct connection to eterm™ Master equipment;
- GSM modem for eterm™ Master equipment and Boiler Control Board;
- Internet connection after free-of-charge registration of the system on www.eterm.it.

Software licenses are available in three versions:

Eterm™PCmanager base version:

- permanent base version that allows configuration, management and remote control according to the above-mentioned methods. It does not allow reading, storing and processing consumption data.

Level 2 Eterm™PCmanager version:

- in addition to configuration, management and remote control according to the above-mentioned methods, this version allows reading, storing and processing consumption data. In order to be able to exploit the advantages of this software, it is advisable to participate in the training courses (subject to payment) that ICI Caldaie organises at its headquarters at 38 Via Giovanni Pascoli, situated in Zevio (Verona). Software license can be installed on a single computer and it provides for the management of a single system.

Synoptic configurator version:

- this software version enables the user to create a synoptic of the system, that is a scheme through which it is possible to view the system and data detected by the installed equipment. The whole process can be made via WEB without installing the eterm™PCmanager software.

The eterm™PCmanager software requires Windows operating system.



RESIDENTIAL AREA

The services on this page are available for:

Assembly

Some boilers can be assembled directly in the plant room. This service is provided for all those situations where it is impossible or too difficult and expensive to introduce the whole boiler in the plant room because of its dimensions or too limited access.

The assembly operations are performed by our reliable welders on site and consequently travelling expenses are excluded. With reliable welders we mean expert professional welders already certified to perform such delicate operation.

Some boilers can be assembled directly in the plant room.

Basic service Nereix (BSN)

The service is dedicated to condominiums where ICI Nereix modules are installed and tested.

It can be applied to residential buildings with heat meters with Meter Bus output, by installing the suitable centraliser.

The service consists in loading and saving on the website www.eterm.it the consumption data transmitted automatically by the system. On the website there is a web application (etermEASYmanager) that allows the users and administrator to view and download the consumption data.

This service does not include:

- allocation calculations;
- checking the data consistency;
- alarms for faults, errors and tampering;
- ordinary and extraordinary maintenance;
- warranty extension.

Advantages for the condominium:

- reading of consumptions and monitoring of historical data using graphs;
- sending of commands to the ICI Kronos and e-Kronos environment unit (if any).

Advantages for the administrator:

- reading and storing on the web the consumption data of all residential buildings;
- exporting the consumptions in Excel tables.

Should it be not technically possible to connect or configure the system from remote, ICI Caldaie will perform an on-site operation that will be invoiced in accordance with the rate book.

ICI Caldaie reserves the right to examine whether it is possible to provide the service, that is, network coverage GSM – GPRS, presence of the “master” control unit with modem and a bus network correctly wired and functioning.

Start-up of Nereix modules

In Italy, the start-up of Nereix modules is a necessary condition before drawing up a Basic Service Nereix (BSN) contract

The described service could be unavailable in some Countries.
Please, contact our commercial department for confirmation.

GENERAL CONDITIONS OF SALE

1) INTRODUCTION

The sale is carried out under the following general conditions, which form an integral part of the contract drawn up between the Parties. Entering into the contract decrees approval of the conditions below and any modifications of the aforesaid must be carried out exclusively in writing.

2) COMPLETION OF THE CONTRACT

The contract is completed when, after receiving a purchase order, the seller confirms its acceptance to the purchaser. This acceptance can be made by a sale confirmation or by the commencement of the contract without any obligation of having to give notice to the other party.

3) DESCRIPTIVE DOCUMENTS AND STRUCTURAL CHANGES

The weights, dimensions, capacity, price, performance, and any other data represented in catalogues, lists, circulars, advertisements, illustrations and price lists are for information purposes only and are not obligatory.

The seller reserves the right to make any structural changes to his products at any time, which is deemed necessary in order to guarantee operation and efficiency.

4) PACKAGING

Unless otherwise agreed upon, the prices listed in the offers also include standard packaging of the goods;

Maritime, wood, or any other type of non-standard packaging is deemed not included in the sale price, and is to be borne by the purchaser.

5) RISK TRANSFER

Unless otherwise agreed upon in writing, the goods are sold "ex works" with reference to the EXW Incoterms® 2010 clause.

In particular, the risk, transport expenses and other relative expenses to load the goods onto the vehicle are to be borne by the purchaser from the time in which the goods are made available in compliance with the contract, provided that the seller notifies the purchaser in writing with regard to the date from which the goods can be collected

6) DELIVERY

Unless otherwise agreed upon, the delivery period shall start from the later date from the following:

- the date of completion of the contract as stipulated in Art. 2;

- the date of receipt of any payment on account or deposit made by the seller, which is provided for in the contract prior to delivery of the goods;

Unless otherwise agreed upon in writing, the delivery conditions of the said goods to be sold are deemed estimated.

If, for whatever reason, which is not an action or negligence by the seller, the purchaser fails to collect the goods at the time and place agreed upon in the contract, he shall in any case effect all payment established in the contract as though the goods were delivered. In this case, when the goods are identified, the seller shall store them at the expense and risk of the purchaser.

The seller also has the right to reimbursement of all expenses incurred to enforce the contract and not covered by any payments received, with the exception of the right to compensation for damages.

7) PRICE AND PAYMENT

Unless otherwise agreed upon, the price for the goods is agreed upon as "Ex Works". Therefore, transport expenses and any additional expenses are therefore excluded, including taxes due as local taxes.

Payment is due by the date established in the contract, without any other request or formality by the seller. Delay in payment shall result in interest accrued pursuant to Italian Legislative Decree 231/2002, which adopts and implements EU directive 2000/35/EC.

If the purchaser delays any payment whatsoever, the seller, at his discretion, shall:

- suspend or postpone obligations held;

- declare the contract terminated by way of simple written notice without prejudice to his right to be reimbursed for all expenses incurred in the performance of the contract, except for the right to compensation for damages.

8) WARRANTY AND EXCLUSIONS

The seller shall undertake to repair faults resulting from design, material or processing defects, exclusively within the following limits.

The obligation undertaken by the seller is limited to defects that occur during the period called "warranty period", which shall come into effect from risk transfer, which corresponds to the provisions of Art. 5, until the expiry of the terms set forth below;

The parties agree that the warranty includes repairs or replacement of parts, which, at the discretion of the seller, are necessary for the proper operation of the product, within the said warranty conditions, in particular, the seller recognises each construction defect found, in the following terms, for:

- Commercial range steel boiler body 36 months

- Industrial range steel boiler body 12 months

- Condensing range boiler body 36 months

Storage tank body 12 months

- Electrical and electronic parts and/or accessories 12 months

from the aforesaid date of risk transfer.

The warranty does not include maintenance operations of the devices regarding the contract of sale, which shall be borne by the purchaser;

In order to make use of the warranty as indicated in this article, the purchaser shall, without delay, give notice in writing not later than eight days, under penalty of invalidation, from the date of delivery, the defects that were detected. This action is barred after a period of one year, or other period as indicated above;

The aforesaid notification shall not release the purchaser from his obligation of payment under the terms agreed upon. Delay, failure, or incorrect payment shall result in a disclaimer of the warranty referred to in this article.

Execution of the warranty shall take place upon technical verification and recognition of the alleged defect at the premises of the seller, and according to company procedure. The purchaser of the device is to pay the fixed minimum charge for any intervention required, of the cost of transport of the pieces to be replaced, of labour costs, with the exception of those related to any repairs and any travel, food and accommodation expenses of the seller's personnel using the rate in force. Technical personnel shall be sent within the time granted by organisational requirements.

Any replacements or repairs shall not modify the start date and duration of the warranty established in the sales contract or in these general conditions. The replaced parts and components shall be the property of ICI CALDAIE S.p.a. and must be returned by, and at the expense of, the purchaser.

The seller's responsibility is solely extended to defects that emerge in the operating conditions provided by the contract and used correctly, as specified in the relative user instructions in the installation manual that always precedes or accompanies the delivery of the product. The seller's responsibility is excluded for defects resulting from faulty installation, maintenance, and use; due to insufficient capacity or abnormality of hydraulic systems, fuel supply; for use that differs from what the product was built for; for unsuitability or otherwise erroneous and incorrect supply water treatment; for corrosion caused by water condensation and aggressiveness; for badly conducted treatments; for stray currents; for negligence or inability of use; due to frost; due to lack of water; for inefficiency of the chimneys or discharges; for tampering by unqualified or unauthorised personnel; for parts subject to normal wear and tear of use, for anodes, refractories, gaskets, knobs, warning lights, etc., and in any case, for reasons not to be ascribed to ICI CALDAIE S.p.A.

In the event of failure to find the manual of use mentioned in the previous point, the purchaser shall submit a notice in writing to the seller within a period of eight days from delivery of the product. Failure to submit the said notice shall imply the manual was delivered with one of the products.

Subject to what is provided in this article, from the risk transfer of the goods and also for defects whose cause is prior to the said transfer, the seller shall not undertake other responsibilities. It expressly provides that the purchaser cannot raise any claim for injury to persons or damage to property

The parties can also establish to limit the seller's responsibility of gross negligence, unwavering the significance of all references in this regard made in these general conditions.

After the warranty duration terms, technical assistance can be carried out by charging the purchaser for any replaced parts or for expenses related to repairs, provided that all labour and travelling expenses of personnel and transport of materials are to be borne by the purchaser according to the rate in force by the seller.

9) INSTALLATION AND OPERATION

ICI sells a product.

Installation is to be carried out by the purchaser, who must execute the provided technical provisions by the laws and regulations in force and, in any case, by the relative technical manual, including assembly, start-up, and operation.

10) REASONS FOR EXEMPTION FROM EXECUTION

A party is not responsible for the failed execution of any of its obligations should:

- Failed execution be due to an impediment beyond his control;

- The party, upon concluding the contract, could not be reasonably held to envisage the said impediment and its effects on the position to execute the contract;

- The party could not have reasonably avoided or overcome such an impediment or its effects;

A cause of exemption from liability pursuant to this article exempts the defaulting party from payment of damages, penalties and other contractual sanctions.

It also suspends the terms of execution of the contract for a reasonable period, excluding any counter-party's right to cancel or terminate it.

Each party can retain what he has held from execution of the contract before it was ended. The final payment must be effected without delay.

11) AMENDMENTS

Any amendment to these General Conditions of Sale can be effective only if made by means of a written act

12) APPLICABLE LAW AND PLACE OF JURISDICTION

With regard to any disputes, the parties agree that the contract shall be governed by the United Nations Convention on contracts for the international sale of goods, concluded in Vienna on 11 April 1980, signed by the Italian State on 30 September 1981, ratified by Law No. 765 on 11 December 1985, and entered into force on 1 January 1988.

The right to apply Italian law with regard to what is not expressly governed by the United Nations Convention on contracts for the international sale of goods shall be valid.

For any dispute or litigation that may arise or result from this provision, the Court of Verona shall have jurisdiction.



ICI Caldaie S.p.A.

Via G. Pascoli 38 - 37059
Campagnola di Zevio (Verona) Italy
Tel. +39 045 8738511
Fax +39 045 8731148
icicaldaie.com