

ACS20RCRTP

Technical Data

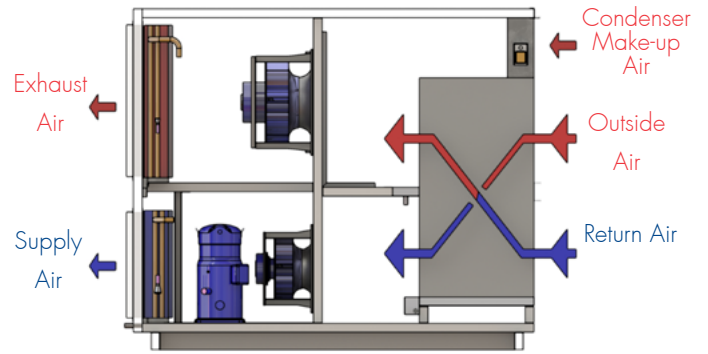

Contact your Air Change representative for a psychrometric unit selection

Airflow

Supply Air	1000l/s (nominal)
Return Air	1000l/s (nominal)
Outside Air	100%
Condenser Make-up Air	600l/s
Exhaust Air (RA + CMA)	1600l/s (nominal)

Refrigeration

Reverse Cycle	Yes
Cooling Capacity	20kW _r (nominal)
Heating Capacity	25kW _r (nominal)
Compressor Type	Single Stage DOL (standard) BLDC Inverter (optional)
Refrigerant	R-407C (Single Stage DOL) R-410A (BLDC Inverter option)

Air-to-Air Heat Exchanger*

HEX Type	Air-to-Air Counterflow Plate
HEX Media	Enthalpy or Sensible-Only

Fans (Nominal Selection)

Type	EC Plug
Total Fans	x1
Nominal Power	2.5kW
Fan Diameter	350 mm
Fan Speed (max.)	2970RPM
Motor Efficiency Class	IE4
Ingress Protection Class	IP54
Impeller Construction	Non-metallic Composite
Speed Control	Integrated Constant Volume Control or via External Speed Signal

Fans (Nominal Selection)

Type	EC Plug
Total Fans	x2
Nominal Power	2.5kW
Fan Diameter	350 mm
Fan Speed (max.)	2970RPM
Motor Efficiency Class	IE4
Ingress Protection Class	IP54
Impeller Construction	Non-metallic Composite
Speed Control	Integrated Constant Volume Control or via External Speed Signal

Electrical & Controls

Electrical Input	415V / 3ph / 50Hz
Full Load Amps	Refer to electrical page
Controls	Low Level Interface (standard) ClimaSync Control System (optional)

Cabinet

Weatherproof	Yes
Panel Construction	50 mm PIR Sandwich Panel (FM Approved 4880/4881 - Class 1)
Panel Finish	Colorbond "Surfmist"
Panel R-Value	2.63 K.m ² /W
Panel Joiner Material	UV Resistant Polymer
Base Frame	Galvanised Steel with Lifting Lugs
Filter Section	Not included (filters to be mounted in RA & OA ductwork)

Operating Modes

Energy Recovery	Default
Economy Cycle	HEX Bypass for Free Cooling (optional)
Return Air Bypass	HEX Bypass for Recirculation (optional)

* The plate heat exchangers are designed to operate to a maximum 300Pa pressure differential (inlet condition) between primary and secondary air streams.

ACS20RCRTP

Dimensions

Standard Configuration*

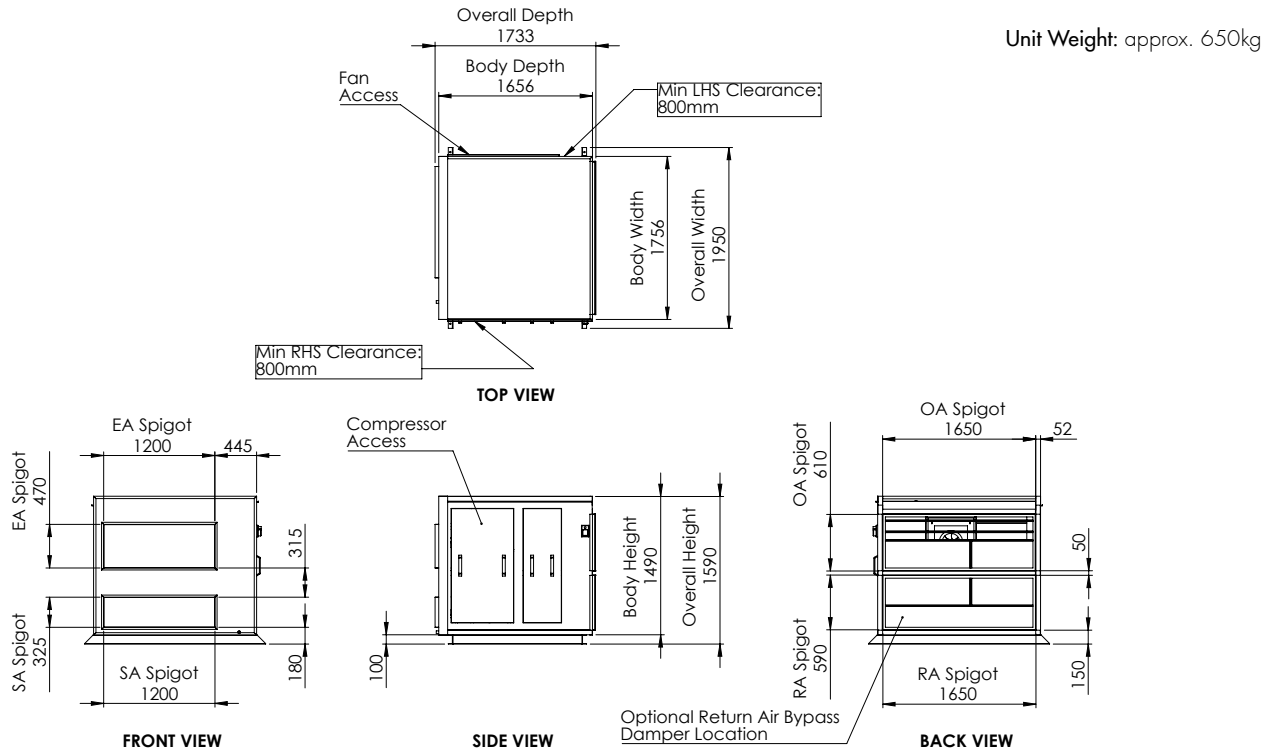

Economy Cycle Configuration*

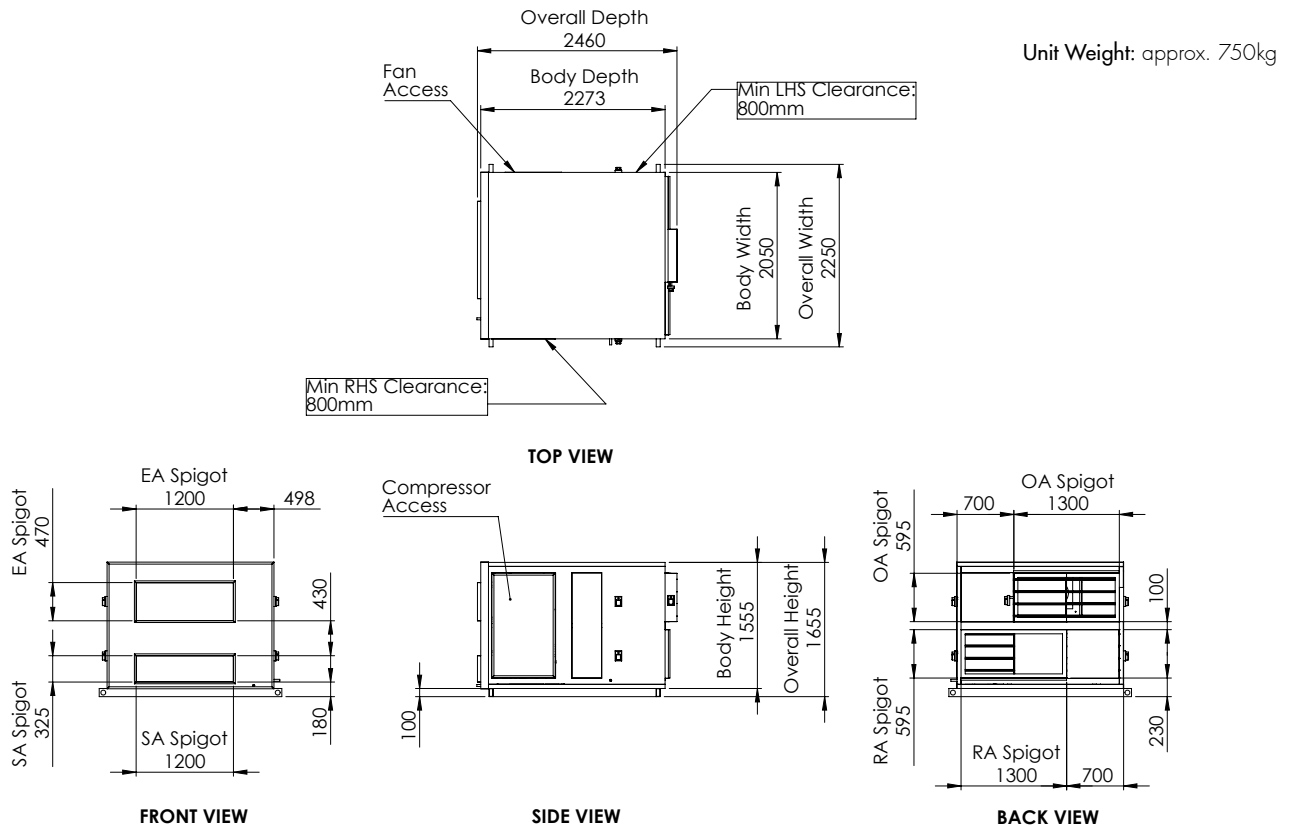

* Dimensions and weight are subject to change, depending on project requirements (incl. compressor option). Refer to project certified drawings for finalised details.

ACS20RCRTP

Electrical

Wiring Diagram (Standard Low Level Control Interface)*

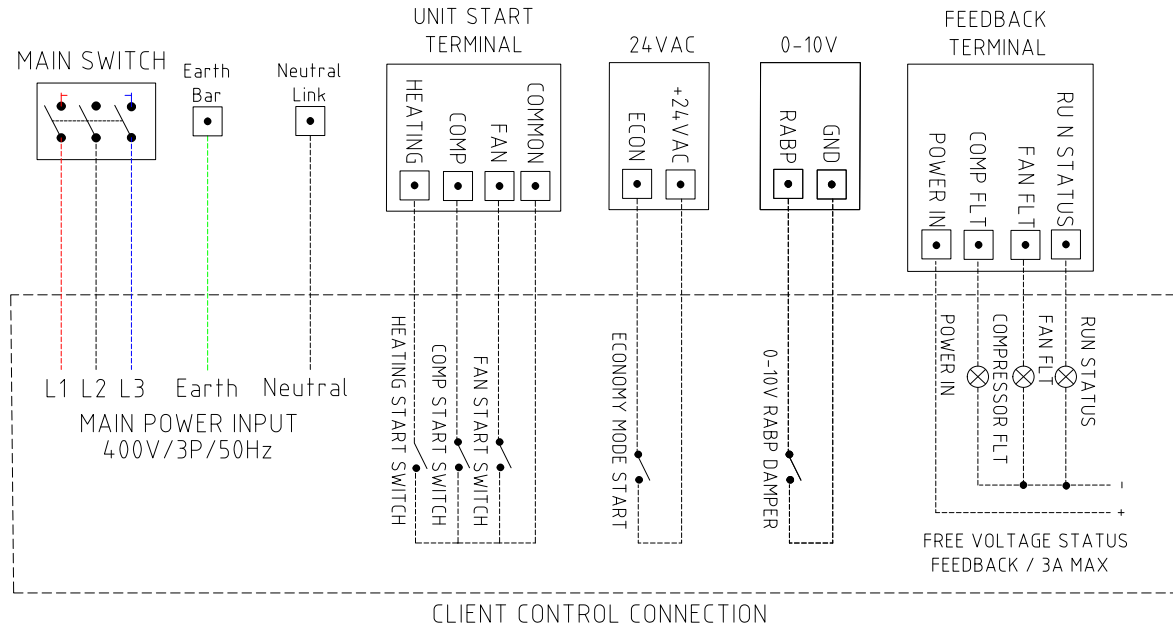

Wiring Diagram (Optional ClimaSync Control System)*

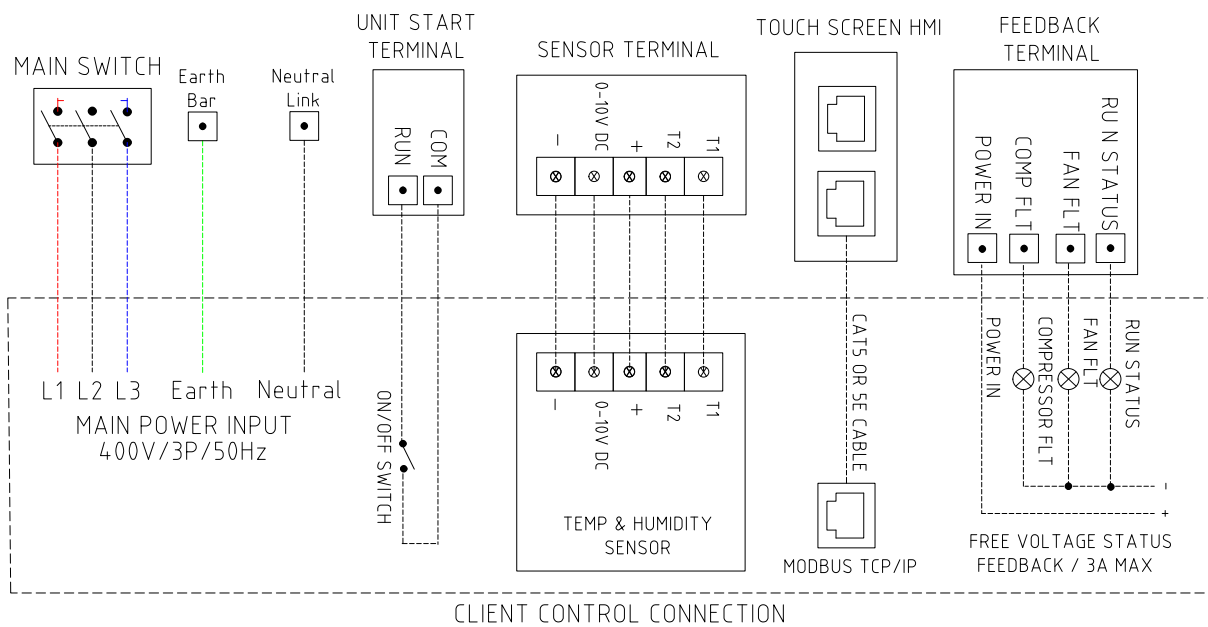

Electrical Input

Indicative Electrical Input details†

	DOL Compressor (standard)	BLDC Inverter Compressor (optional)
Voltage / Phases / Frequency	415V / 3ph / 50Hz	415V / 3ph / 50Hz
Full Load Amps	25A	29A

* Connection details are subject to change, depending on project requirements. Refer to project certified electrical diagrams for finalised details.

† Unit FLA is subject to change, depending on project requirements. Refer to project certified electrical diagrams for finalised details.

ACS20RCRTP

Airflow & Noise

Supply Air Fan Curve*

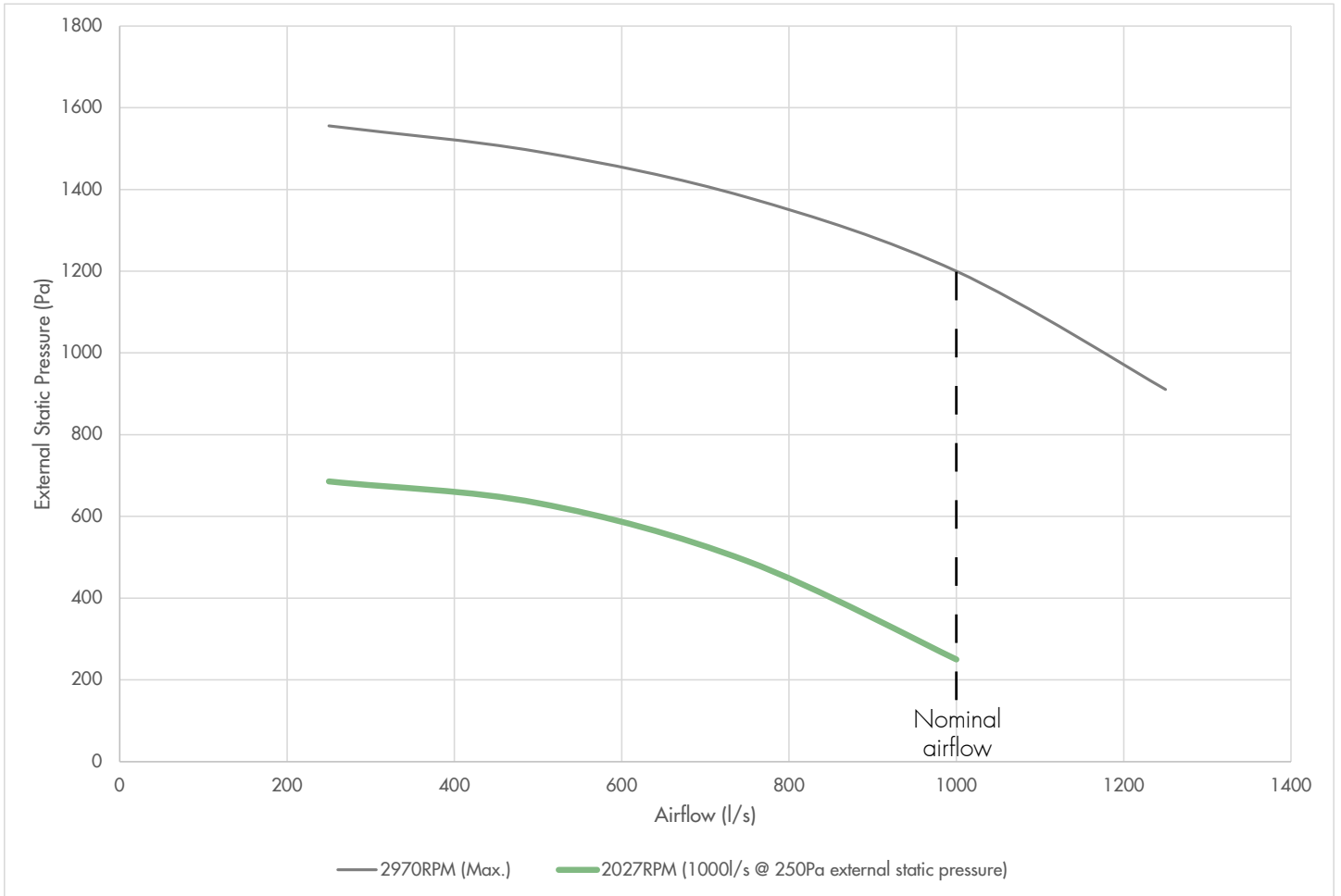

* Fan curve makes allowance for internal pressure drop of unit. This pressure drop is subject to change, depending on project requirements. Supply air fan selection options are available.

Supply Air Fan Acoustics (Sound Power)†

1000l/s @ 250 Pa External Static Pressure

Inlet

Frequency (Hz)	sum	63	125	250	500	1000	2000	4000	8000
A-weighted (dB)	71	37	48	61	66	63	64	61	59
Non A-weighted (dB)	74	63	63	70	69	63	63	60	60

Outlet

Frequency (Hz)	sum	63	125	250	500	1000	2000	4000	8000
A-weighted (dB)	78	40	51	65	69	74	72	68	63
Non A-weighted (dB)	80	65	66	74	73	74	71	67	65

† Noise data considers supply air fans only, without attenuation by the cabinet. Filter drop to be factored into the 250Pa external static pressure allowance.

ACS20RCRTP

Airflow & Noise

Exhaust Air Fan Curve (incl. Condenser Make-up Air)*

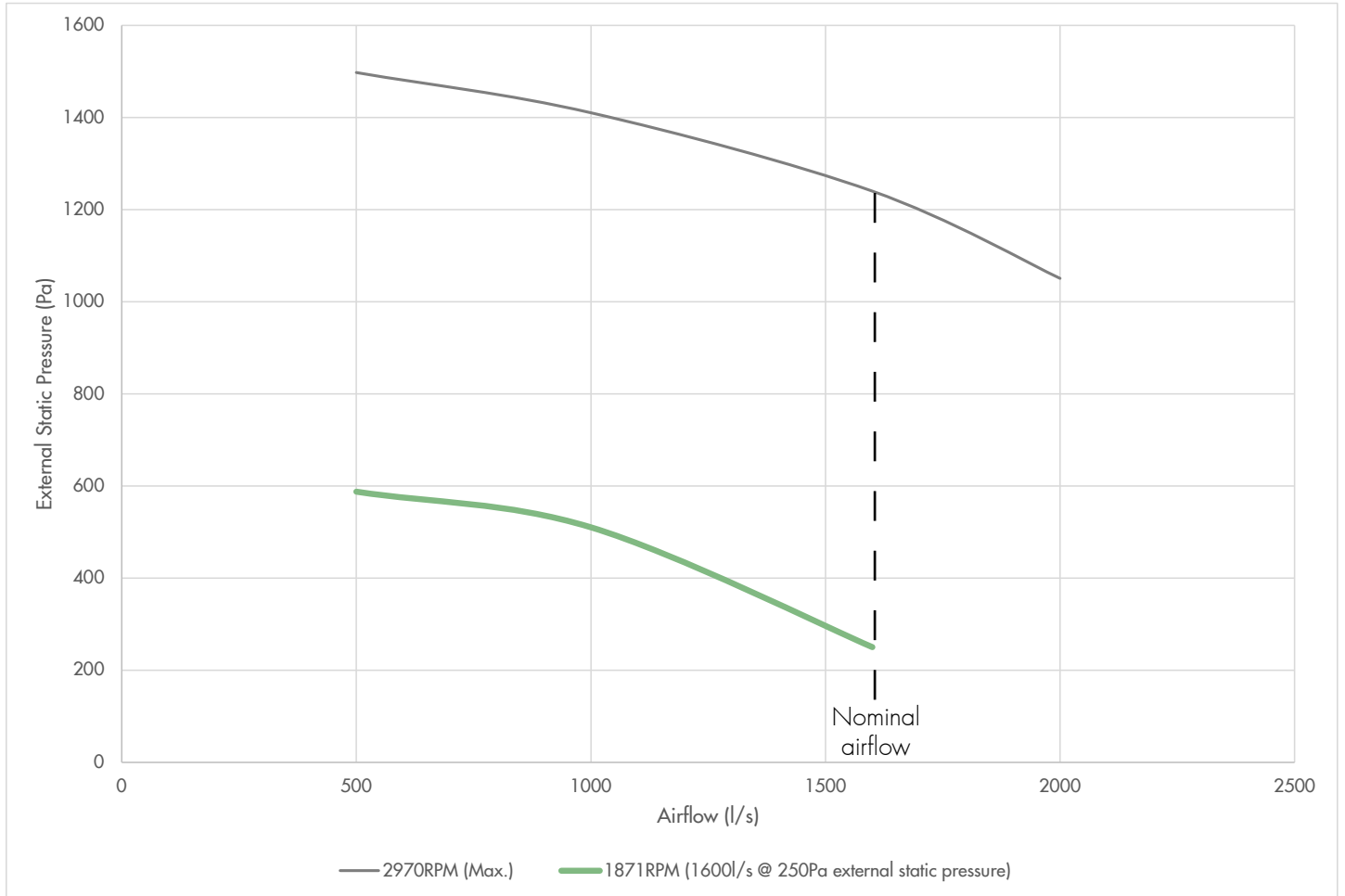

* Fan curve makes allowance for internal pressure drop of unit. This pressure drop is subject to change, depending on project requirements. Exhaust air fan selection options are available.

Exhaust Air Fan Acoustics (Sound Power)†

1600l/s @ 250 Pa External Static Pressure

Inlet

Frequency (Hz)	sum	63	125	250	500	1000	2000	4000	8000
A-weighted (dB)	73	38	53	63	68	65	66	64	59
Non A-weighted (dB)	77	64	67	72	72	65	65	63	60

Outlet

Frequency (Hz)	sum	63	125	250	500	1000	2000	4000	8000
A-weighted (dB)	79	41	55	67	71	75	73	69	63
Non A-weighted (dB)	82	66	70	76	74	75	72	68	64

† Noise data considers exhaust air fans only, without attenuation by the cabinet. Filter drop to be factored into the 250Pa external static pressure allowance.